

# SB-2000 and SB-2000-P Balance Control Operation Manual

LL-2000 Rev. 1.5

Productivity through Precision™





### **Limited Use License Agreement**

CAREFULLY READ THE FOLLOWING TERMS AND CONDITIONS BEFORE OPENING THE PACKAGE CONTAINING THE PRODUCT AND THE COMPUTER SOFTWARE LICENSED HEREUNDER. CONNECTING POWER TO THE MICROPROCESSOR CONTROL UNIT INDICATES YOUR ACCEPTANCE OF THESE TERMS AND CONDITIONS. IF YOU DO NOT AGREE WITH THE TERMS AND CONDITIONS, PROMPTLY RETURN THE UNIT TO THE DEALER FROM WHOM YOU PURCHASED THE PRODUCT WITHIN FIFTEEN DAYS FROM DATE OF PURCHASE AND YOUR PURCHASE PRICE WILL BE REFUNDED BY THE DEALER. IF THE DEALER FAILS TO REFUND YOUR PURCHASE PRICE, CONTACT SCHMITT INDUSTRIES, INC. IMMEDIATELY AT THE ADDRESS FOLLOWING CONCERNING RETURN ARRANGEMENTS.

Schmitt Industries, Inc. provides the hardware and computer software program contained in the microprocessor control unit. Schmitt Industries, Inc. has a valuable proprietary interest in such software and related documentation ("Software"), and licenses the use of the Software to you pursuant to the following terms and conditions. You assume responsibility for the selection of the product suited to achieve your intended results, and for the installation, use and results obtained.

#### **License Terms And Conditions**

- a. You are granted a non-exclusive, perpetual license to use the Software solely on and in conjunction with the product. You agree that the Software title remains with Schmitt Industries, Inc. at all times.
- b. You and your employees and agents agree to protect the confidentiality of the Software. You may not distribute, disclose, or otherwise make the Software available to any third party, except for a transferee who agrees to be bound by these license terms and conditions. In the event of termination or expiration of this license for any reason whatsoever, the obligation of confidentiality shall survive.
- c. You may not disassemble, decode, translate, copy, reproduce, or modify the Software, except only that a copy may be made for archival or back-up purposes as necessary for use with the product.
- d. You agree to maintain all proprietary notices and marks on the Software.
- e. You may transfer this license if also transferring the product, provided the transferee agrees to comply with all terms and conditions of this license. Upon such transfer, your license will terminate and you agree to destroy all copies of the Software in your possession.

# Operation and Specification Manual

for SB-2000 and SB-2000-P Manual Balance Controls

## **SB-2000**

(Dedicated Installation Version)

and

## **SB-2000-P**

(Portable Version)

**LL- 2000**

Manual Revision # 1.5

© 2013 Schmitt Industries, Inc.

### **Corporate Offices**

2765 NW Nicolai St.  
Portland, OR 97210 USA

[sbs-sales@schmitt-ind.com](mailto:sbs-sales@schmitt-ind.com)

Tel: +1 503.227.7908

Fax: +1 503.223.1258

[www.schmitt-ind.com](http://www.schmitt-ind.com)

### **Schmitt Europe Ltd**

Ground Floor Unit 2  
Leofric Court, Progress Way  
Binley Industrial Estate  
Coventry, CV3 2NT, England

[enquiries@schmitt.co.uk](mailto:enquiries@schmitt.co.uk)

Tel: +44-(0)2476-651774

Fax: +44-(0)2476-450456

[www.schmitteurope.com](http://www.schmitteurope.com)





## SB-2000 and SB-2000-P











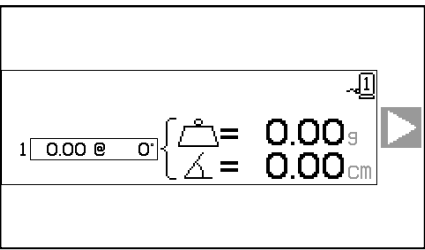

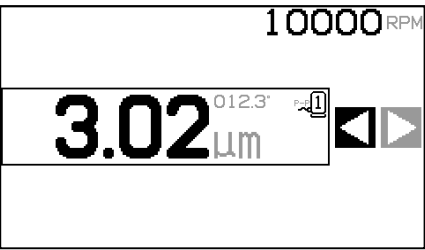
This manual describes the operation and use of the both SB-2000 and SB-2000-P SBS Manual Balance Control. Operation of both versions of the product is virtually identical, with the two configurations covering the needs of either dedicated installation on a single machine, or portable operation on a variety of machines.

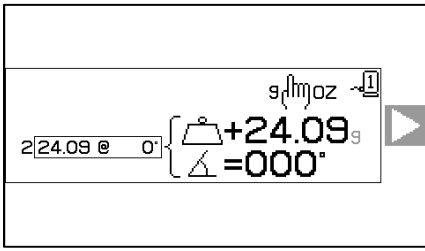
### Benefits of both SBS SB-2000 and SB-2000-P Balance Control:

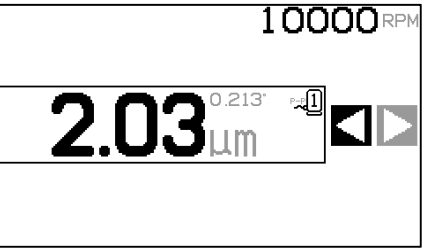
Feature Set	SB-2000	SB-2000-P
Allows single or 2-plane manual balance operation	•	•
Enhanced digital electronic design with increased operating life and reliability	•	•
Easy to install and operate	•	•
Increases throughput by saving setup time	•	•
Improves part quality	•	•
Extends life for grinding wheels, dressing wheels and spindle bearings	•	•
Backed by world-class SBS customer service	•	•
Icon based user interface for international operation	•	•
Provides for plotting and saving vibration spectrum information	•	•
USB port for output of vibration plots and data	•	•
Supports dedicated single machine installation	•	
Proximity RPM sensor triggers on rotating feature	•	•
Screw mount to machine panel	•	
CNC/PLC connection allows machine integration	•	
Uses standard SBS cables (same as SB-5500)	•	
Supports portable use (move from machine to machine)		•
Optical RPM sensor for easy portability	•	•
Magnetic mount of control to any convenient machine surface		•
Uses multiple operation cable connections		•
Available as part of a complete kit, including carry case		•

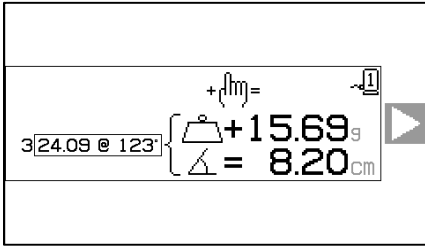
## Quick Start Guide for Balancing

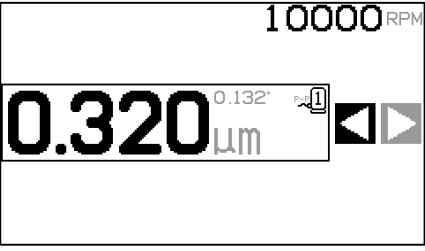
- 1) Calibrate the RPM sensor so the spindle speed is reported on the main screen.
- 2) Press  button to setup controller for number of planes and vibration units. Press  again. Edit the Limit, Tolerance and Critical vibration values, balancing method and scale direction. Each plane has a separate setup screen. Press  after configuring the first plane to access the second plane setup screen, if needed, or to return to the main screen.
- 3) Press  to start a balance cycle. The screens below are for single point balancing.

	Stop Spindle	Place Weights	Start Spindle	Measure Vibration
<b>Initial Phase (Step 1)</b>				
<b>Test Phase (Step 2)</b>				
		 Test mass value and units can be edited.		
<b>Solution Phase (Step 3)</b>				
		 Toggles solution between Additive (+) and Absolute (=).		If the resulting vibration is above the Balance Limit, a new solution will be provided to correct the residual vibration. If below, the process ends.

Additive Solution (+) leaves all existing weights and adds only what is shown.

Absolute Solution (=) removes all existing weights then adds what is shown.

**If the balance gets worse after the solution phase, check that the scale direction setting is correct.**

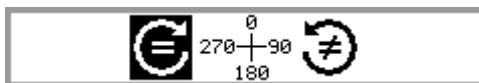

# Table of Contents

<b>System Purpose</b> .....	<b>1</b>
<b>Operator Safety Summary</b> .....	<b>1</b>
<b>Balance Theory</b> .....	<b>2</b>
<b>Manual Balance Overview</b> .....	<b>2</b>
<b>Environmental Considerations</b> .....	<b>2</b>
Other Sources of Vibration .....	2
Machine Condition .....	3
<b>System Installation</b> .....	<b>4</b>
Control Unit.....	4
System Connections, SB-2000 model .....	4
System Connections, SB-2000-P model .....	5
Vibration Sensor Location .....	6
RPM Sensor .....	7
<b>Control Unit Operating Instructions</b> .....	<b>8</b>
Front Panel Controls.....	8
<b>Startup</b> .....	<b>9</b>
Power-On Display.....	9
Main Screen.....	9
<b>Preparing to Set Operating Parameters</b> .....	<b>10</b>
Background Vibration / Manual RPM Entry .....	10
Limit .....	10
Tolerance.....	11
Critical Vibration.....	11
<b>Operation Overview</b> .....	<b>11</b>
Navigation and Edit Conventions .....	11
Multiple Machine Operation .....	12
<b>Balance Process</b> .....	<b>13</b>
Setup .....	13
Balance Process Overview.....	16
Trim Balance.....	16
Dual Plane Balance .....	17
① Single Point Balance Process.....	22
②③ 2 and 3 Weight Balance Process.....	26
⚠ Fixed Position Balance Process .....	31
<b>Plot Function</b> .....	<b>34</b>
Plot Selection Screen .....	34
Plot Setup Screen.....	35
Run Plot Screen .....	35
Plot View Screen .....	36
Delete Plot Confirmation.....	36
<b>USB Interface</b> .....	<b>37</b>
Interfacing.....	37
<b>Hardwire Interface</b> .....	<b>37</b>
Hardwire Interface Overview .....	37
Input Pin Names and Functions .....	38
Output Pin Names and Functions.....	39
<b>System Maintenance</b> .....	<b>40</b>
RPM Sensor Cable (SB-18xx).....	41
RPM Sensor Extension Cable (SB-19xx and SB-35xx).....	41
Vibration Sensor .....	41
SBS Return/Repair Policy.....	41
<b>Trouble Shooting Guide</b> .....	<b>42</b>
<b>Error Messages</b> .....	<b>43</b>
<b>Appendix A: Specifications</b> .....	<b>44</b>
<b>Appendix B: Replacement Part List</b> .....	<b>44</b>
<b>Appendix C: System Connection Diagram</b> .....	<b>45</b>

## System Purpose

In order for the wheel of a grinding machine to accurately cut, produce smooth surface finishes, and generate correct part geometry, it is necessary to prevent vibration in the grinding process. A primary cause of vibration during grinding is the existence of imbalance in the grinding wheel. This is often due to the heterogeneous nature of the grinding wheel, which contains great numbers of unevenly distributed grains, causing intrinsic imbalance. This imbalance can be compounded by eccentric mounting of the wheel, varying width of the wheel, imbalance in the arbor, and coolant absorption into the wheel. Considering all these factors, even a carefully established initial balance will not last long. Furthermore, due to wear and dressing, the rotational dynamics of a grinding wheel are always changing. For these reasons, dynamic balancing of grinding wheels has long been recognized as an important step in the production process.

The SBS Balance System has been developed to provide dynamic balancing for grinding machine operators with the following objectives in mind:

- **Ease and Usefulness of Operation**
- **Minimal Installation Requirements**
- **Attractive Purchase Price**

## Operator Safety Summary

This summary contains safety information necessary for operation of the SBS Balance System for grinding machines. Specific warnings and cautions are found throughout the Operation Manual where they apply, but may not appear in this summary. Before installing and operating the SBS Balance System, it is necessary to read and understand the entirety of this manual. After reading the Operation Manual, contact Schmitt Industries Inc. for any additional technical assistance required.

- Warning:** Observe all safety precautions for operation of your grinding machinery. Do not operate your equipment beyond safe balance limits.
- Warning:** Failure to properly attach SBS Balance System components to the grinding machine spindle, including the proper use of provided adaptor lock screws, will result in safety hazard during machine operation.
- Warning:** Never operate a grinding machine without all proper safety guarding in place.
- Caution:** To avoid equipment damage, make sure the line voltage is within the range specified for the system (see specification section).
- Caution:** Only qualified service technicians should attempt to service the SBS Balance System. To avoid electric shock, do not remove the cover of the Control Unit, or remove cables, with power connected.

## Balance Theory

The SBS Balance System operates on the principle of mass compensation for any given grinding wheel's imbalance. The Intrinsic Imbalance of a grinding wheel is equal to its mass multiplied by "e", the distance between the wheel's center of mass and the wheel's center of rotation.

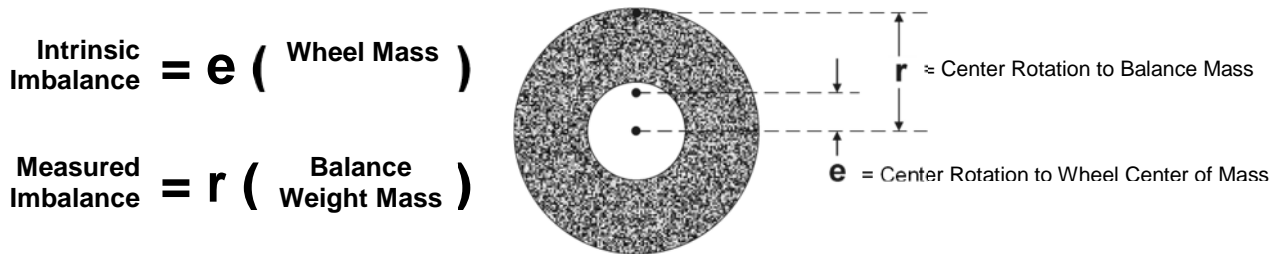

The imbalance of a grinding wheel is determined in practice by use of the Measured Imbalance of the wheel. The Measured Imbalance is equal to the product of the mass of an attached balance weight, located to balance the grinding wheel, multiplied by "r" the distance between that weight's center of mass and the grinding wheel's center of rotation. In both cases, the imbalance is given in terms of a mass multiplied by a distance, with (grams)(centimeters) being the default units used for reference by the system.

The SBS system with SB-2000 control can operate in single or 2-plane Manual Balance mode in order to correct for wheel imbalance.

## Manual Balance Overview

The SB-2000 control can be used as an aid in performing manual balance operations, where the cost of a fully automatic system is not warranted. An RPM sensor is used to monitor the RPM and phase position of the rotating spindle. An RPM signal which is not time synchronized to a specific physical location on the spindle assembly is not adequate to achieve balance (such as from the motor or other source). An RPM sensor with a fixed position trigger point must be used to allow the phase position of the spindle to be determined.

Balance weights are either moved or added on the grinder manually by the operator as needed to achieve balance. The SB-2000 assists the operator by analyzing the current balance condition of the grinder and showing the operator how to position weights to achieve balance.

## Environmental Considerations

The SBS Balance System is designed to correct for grinding wheel imbalance and its detrimental effects on quality of surface finish, part geometry, and wheel and machine bearing life. The system cannot correct for other environmental sources of vibration on the machine. This section is intended as a discussion of some common environmental problems which may influence grinding quality.

### Other Sources of Vibration

A common source of vibration is adjacent machinery. Grinding machines should be properly isolation mounted if vibration-producing machinery is operating nearby. Other sources of vibration may also include components mounted on the machine itself, such as pumps, motors, drives, etc.

The SBS Balance System may not operate efficiently under the influence of some external vibrations. The system filters the vibration signal it detects from the grinding machine by the frequency of the spindle RPM. Vibrations occurring at frequencies other than that of the rotating wheel will be ignored by the system. However if adjacent machinery or auxiliary equipment on the grinder is operating near the same frequency as



the spindle rotation, the system will not be able to distinguish between vibrations occurring from wheel imbalance and those originating elsewhere.

An excellent test for environmental vibration is to monitor the vibration level on the grinding machine while the spindle is not turning. The vibration level should be checked in various locations on the grinding machine, but in particular at the location the vibration sensor is to be mounted. All surrounding equipment, including any auxiliary pumps or attachments on the grinding machine should be operating during this test. The SBS Balance System can help perform this test but cannot remove these vibrations (*see: Background Vibration section*).

### Machine Condition

Grinding machine condition is an important factor in determining the minimum balance level that the SBS Balance System can achieve. The spindle should be balanced, as well as all components in the spindle drive train (i.e. belts, pulleys, motor, etc.). The balance system can be used to readily determine if any significant imbalance exists in the machine itself. Simply use the same method as described above for checking environmental vibration, except test with the spindle running and with no wheel mounted. The SBS Balance System cannot remove vibration resulting from machine condition problems.

# System Installation

## Control Unit

The SBS Control Unit should be mounted in a location allowing observation of the display by the machine operator. A variety of mounting hardware is available for installation on vertical surfaces or for rack mounting.

## System Connections, SB-2000 model

The following figure shows the rear of the control.

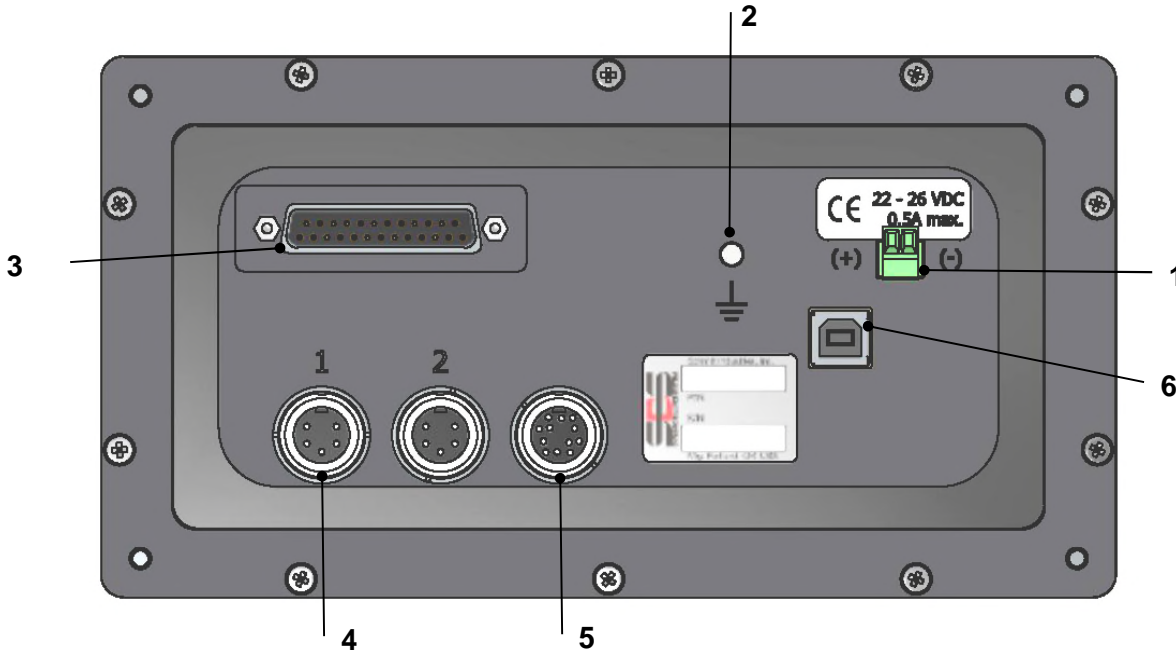

The following connections are located on the rear panel of the Control Unit.

- 1) **POWER SUPPLY.** Terminal block connection for power input. 22 VDC to 26 VDC, 0.5A max at 22 VDC. There is no power switch on the SB-2000, as it is designed for constant operation. If power must be disconnected by the user, a separate switch on the power line may be installed at installation.

**Caution:** Before applying power to the Control, make sure the supply voltage is within specified range.

- 2) **Earth Ground.** Connect this M5 stud to the GND.
- 3) **Optional CNC Interface.** Standard DB-25 connector for connecting to a grinding machine controller. A complete description of this relay based interface is given in the “Hardwire Interface” section
- 4) **Vibration Sensor (x2).** Two 5-pin DIN connections to Vibration sensors #1 and #2.
- 5) **RPM Sensor.** 12-pin DIN connection to the SBS RPM Sensor.
- 6) **USB connection.** Allows USB 2.0 connection to host computer for Firmware update of the control, as well as interface capability as described in the **USB Interface** section of this manual. Latest firmware for the control and update instructions are available on the SBS website [sbs.schmitt-ind.com](http://sbs.schmitt-ind.com)

## System Connections, SB-2000-P model

The following figure shows the rear and side of the control.

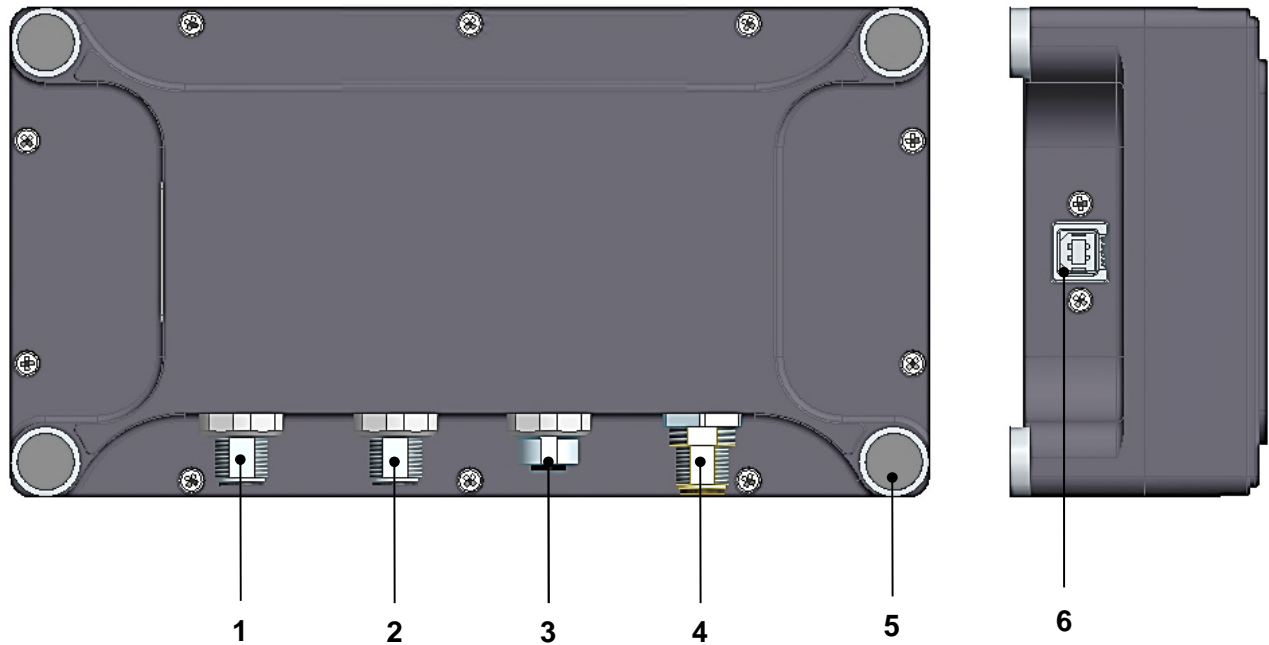

The following connections are located on the rear panel of the Control Unit.

- 1) Vibration sensor 1. 4-pin M12 Male connection.
- 2) Vibration sensor 2. 4-pin M12 Male connection.
- 3) RPM Sensor. 4-pin M12 female connection to the SBS RPM Sensor.
- 4) POWER SUPPLY. 8-Pin M12 Male connection. Use with SB-1875 power supply.

**Caution: Before applying power to the Control, make sure the supply voltage is within specified range of SB-1875 unit.**

- 5) Corner mounting magnets. Allows the SB-2000-P to be temporarily attached to a metal surface while in use.
- 6) USB connection. Allows USB 2.0 connection to host computer for Firmware update of the control, as well as interface capability as described in the **USB Interface** section of this manual. Latest firmware for the control and update instructions are available on the SBS website [sbs.schmitt-ind.com](http://sbs.schmitt-ind.com)

## Vibration Sensor Location

The Vibration Sensor can be mounted on the grinding machine using the magnetic mount provided, or permanent stud mount. The magnetic mount should be used during initial system start up until a good permanent location is found on the grinding machine for the sensor. The sensor can then be permanently stud mounted at that location, using an M5 set screw. A machined flat should be supplied at the mounting location when stud mounting the sensor.

The location and installation of the sensor are critical for successful operation of the SBS Balance System. Because of differing machine characteristics, Vibration Sensor location is specific to the machine model. There are two general principles that should assist in finding a proper sensor location for your grinding machine.

1. **Locate the Sensor in the same direction as the centerline between the grinding wheel and the workpiece.**

The best place to start is a flat machined surface on the spindle housing over the bearing closest to the wheel and perpendicular to the spindle's centerline. A vertical mounting surface is preferable on most cylindrical grinding machines because the sensor is in line with the grinding wheel and the workpiece. For this same reason on surface grinders and creep feed grinders, a horizontal mounting surface is generally best. Although the balancer itself may be mounted either on the wheel or pulley end of the machine, the Sensor should always be aligned at the wheel end of the machine.

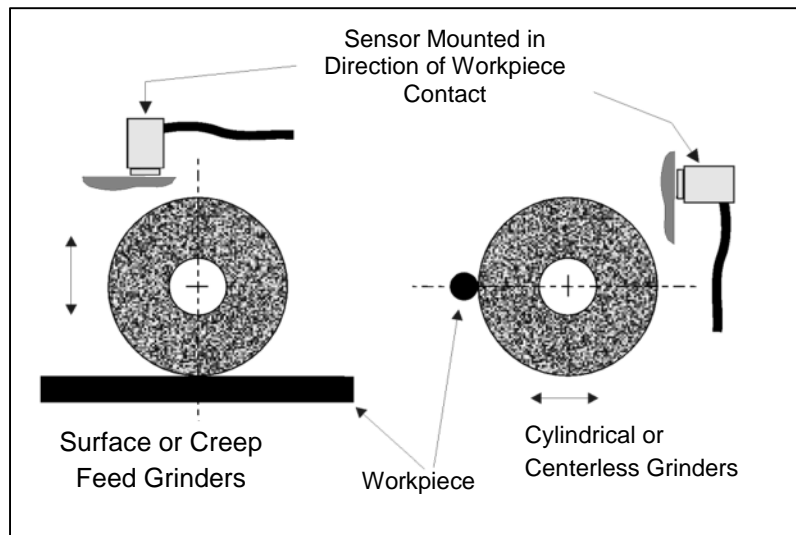

2. **Locate the sensor on a rigid part of the machine structure, where vibration from the spindle will be accurately transmitted.** On some machines the wheel guard can be a good location to mount the sensor, if it is heavy enough and rigidly attached to the spindle housing. The balance system relies on vibration signals received from the Vibration Sensor to accurately display the current vibration level and to balance the grinding wheel. The system employs narrow bandwidth filters that prevent vibration at non-spindle frequencies from being detected. However, in applications where the motor or other machine components are running at the same speed or frequency as the spindle, interfering vibrations may result. Careful experimentation with the sensor's location minimizes sources of interference.

## RPM Sensor

An RPM rate alone (from the motor or other source) is not adequate to achieve balance. An RPM sensor with a fixed position and once per revolution signal must be used so that the phase relationship between the vibration and spindle position may be determined.

Part number:	<b>SB-1800</b>	<b>SB-1802</b>
Installation type:	Permanent	Temporary
Sensor type:	Proximity NPN	Optical NPN
Trigger source:	Surface feature (hole)	Reflective tape
Maximum RPM <sup>1</sup> :		24,000 RPM
Recommended sensing distance:	2mm maximum perpendicular to surface	25-100mm perpendicular to surface
Notes:	1) Surface feature may also be a protrusion from the surface instead of a hole, but must only occur once per revolution. 2) Recommended minimum hole diameter of 8mm.	1) Calibration may be required. <ol style="list-style-type: none"> <li>Align sensor to trigger source.</li> <li>Push Teach Button on sensor for 2-5 seconds until LED turns on constantly.</li> <li>Remove trigger source. Verify LED turns off.</li> </ol> 2) Instead of reflective tape, a black mark may be required if the surface is highly reflective. A change in surface reflectivity is required for proper RPM detection.

<sup>1</sup>Sensor Maximum RPM is defined both by the sensor type used, and by the trigger feature used. Alternate sensors are available for higher RPM applications. Contact SBS for application assistance.

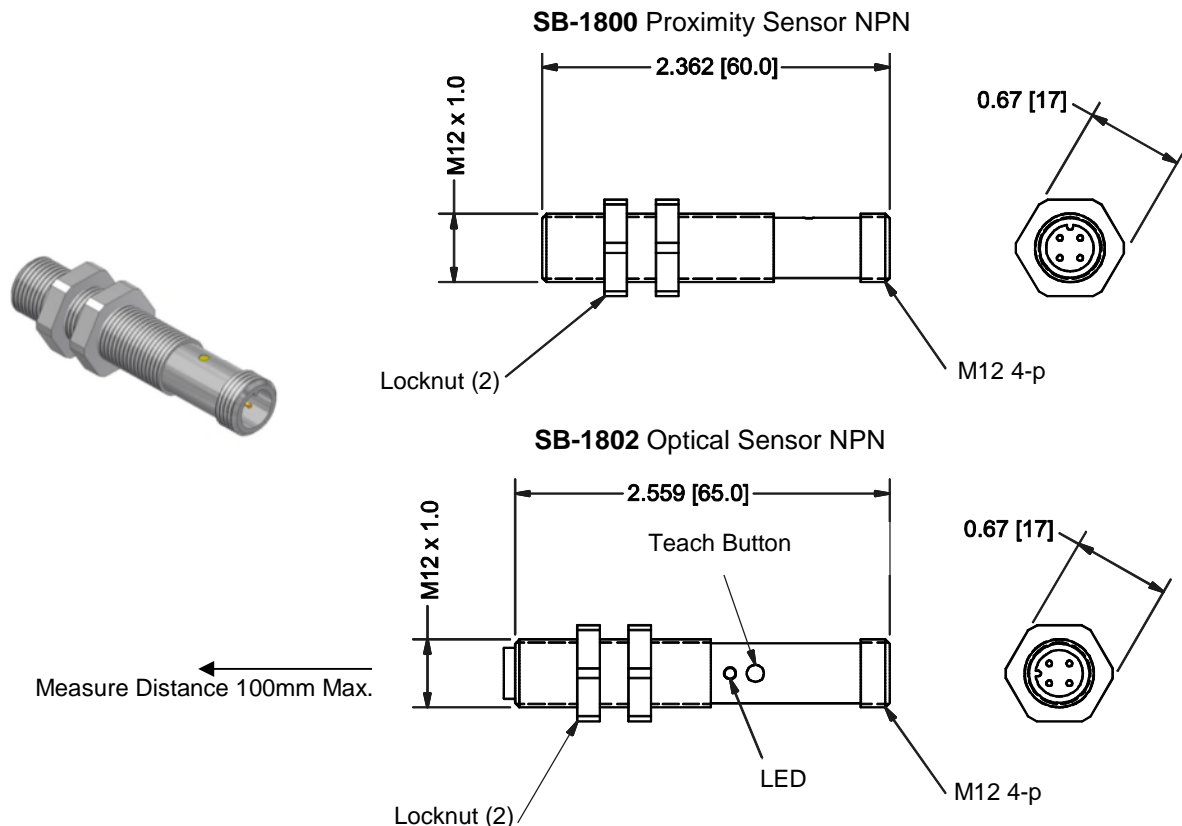







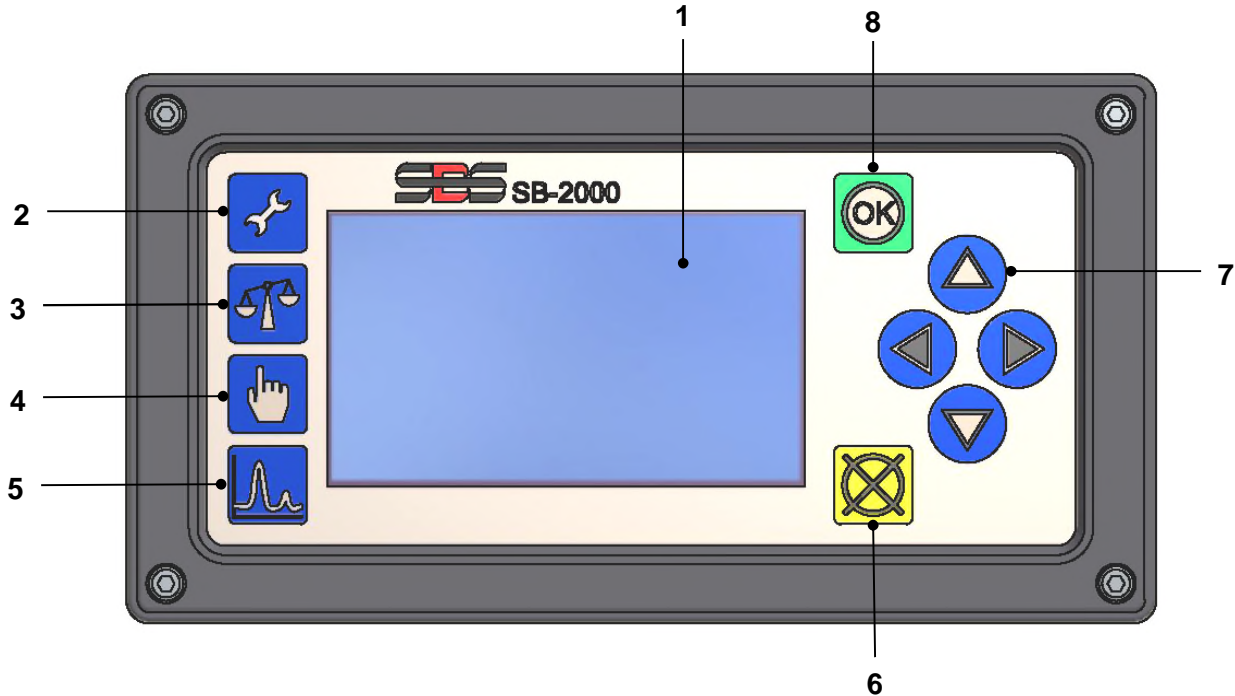

# Control Unit Operating Instructions

## Front Panel Controls

The following figure illustrates the front panel of the Balance Control Unit.



Following is a description of these features:

- 1) LCD Display. This screen is used to display data and show current settings and status information. Information is displayed using a symbol based interface, which is independent of language. The display will dim over a period of about 24 minutes when inactive (no user button presses).
- 2) Setup  button. Press to access the operational settings of the control. Press and hold this button to access the screen for selection of single machine or multiple machine operation.
- 3) Balance  button. Press to start a balance operation.
- 4) Trim/Edit  button. This button is used to initiate a Trim Balance process. It also is used to change values at various steps in the manual balance process.
- 5) Plot  button. Selects plot mode, allowing vibration spectrum plots to be created and saved.
- 6) Cancel  button. Press to cancel the operation in progress, or cancel the last selection or entry made. This button also clears any displayed error message.
- 7) Arrow     buttons. Used to change selected options, or to select and increment digits when editing. See Navigation and Edit Conventions.
- 8) OK button. Used to accept current settings.

## Startup

### Power-On Display

Power on display shows only after power is applied, and displays for 2 seconds. Press and hold the Cancel button to extend the duration of this display until button is released. For support reference, the installed Firmware rev. is displayed, and below that the FPGA code rev. Following this startup screen the unit will display the Main screen when in single machine mode, or will display the Machine Selection screen when in multiple machine mode.





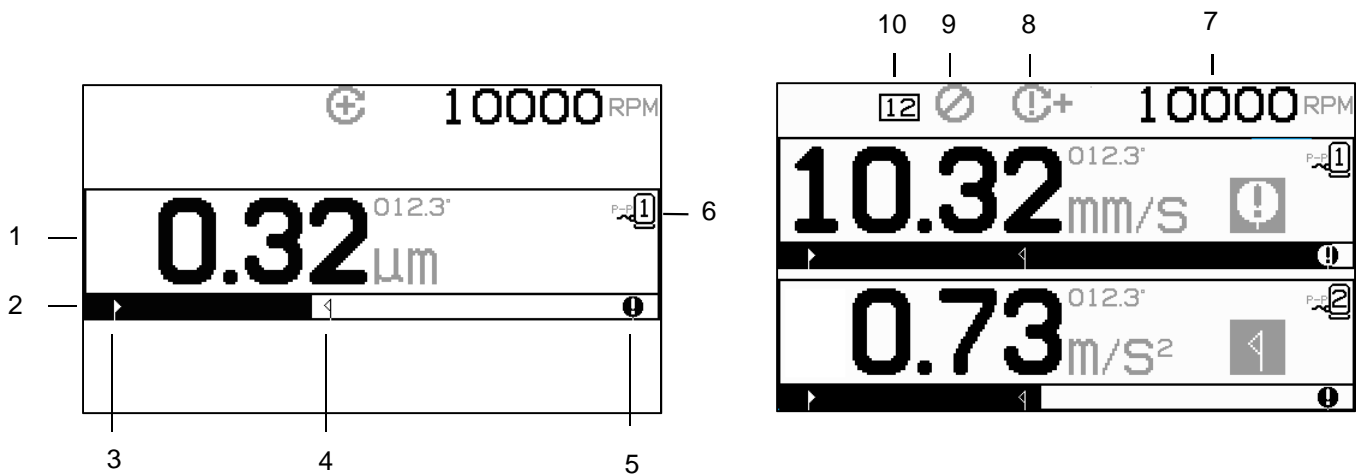

### Main Screen









This is the main display screen of the SB-2000. The first screen shows the display in single plane balance mode, and the second shows the display when in 2-plane balance mode. The first 6 screen elements shown below are specific to a single balance plane, and are duplicated in the 2-plane view.

### Display elements specific to a single balance plane

1. Vibration level indication. Vibration values will not display if there is a vibration sensor error (missing or shorted), or if there is no RPM value displayed. To the right of the vibration display, two Balance conditions will be indicated when they occur:
  - a.  - Tolerance Level exceeded (yellow color). The symbol will flash in yellow if the vibration level rises over the user selected Balance Tolerance limit.
  - b.  - Critical Balance exceeded (yellow color). The symbol will flash in yellow if the vibration level rises over the user selected Critical Balance level.
2. Vibration bar graph. Shows the current vibration level graphically. The scale is linear between the current settings for Balance Limit and Balance Tolerance. A different linear scale applies between the Balance Tolerance level and the Critical Balance level.
3. Balance Limit. This fixed position on the graph indicates the current level set for the Balance Limit, relative to the measured vibration level.
4. Balance Tolerance. This fixed position on the graph indicates the current level set for the Balance Tolerance, relative to the measured vibration level.

5. Critical Balance Level. This fixed position on the graph indicates the current level set for the Critical Balance, relative to the measured vibration level.
6. Sensor# assigned. Indicates if sensor 1 or sensor 2 ( 1 or 2 ) is assigned to the plane displayed.

General display elements, not specific to a single balance plane



7. RPM indication. RPM values will not display if there is no incoming signal (spindle is stopped, or RPM sensor is missing or shorted). A manual RPM value can be set if needed (see Manual RPM Setup)
8. RPM Error indication. Displays one of four icons to indicate RPM error conditions:
  - a. + - (red color) Critical RPM exceeded. The symbol will display and flash if the RPM level is over the Critical RPM user setting.
  - b. - - (red color) RPM Minimum not met. The Symbol will display and flash if the RPM level is below the Minimum RPM user setting.
  - c.  - (yellow color) RPM above operation limit. The symbol will display and flash when the RPM detected is above the maximum operational limit of 102,000 RPM.
  - d.  - (yellow color) RPM below operation limit. The symbol will display and flash when the RPM detected is below the minimum operational limit of 25 RPM.
9.  - Front Panel Inhibit (FPI) is active (see FPI under hardwire interface).
10.  - Machine ID number selected (shown only in multiple machine operation).

## Preparing to Set Operating Parameters

**Ensure you fully understand the function and operation of the Control's front panel as described in previous sections, before attempting the following operations.**

### Background Vibration / Manual RPM Entry

**A check of the background vibration level should be performed to correctly set up the system.**

Install the Control, and all cables as indicated in the installation section of the manual. Leave the grinding machine off. Press the  button, then on the following screen press the  button to manually enter the operational RPM of the grinding machine. Note this measured ambient vibration level without the machine running.

Turn on all secondary machine systems (such as hydraulics and motors), but leave the machine spindle turned off. The vibration level displayed without the spindle running is the background vibration level for the machine. Note this background vibration level for future reference in setting the operating parameters of the system. Refer to the “Environmental Considerations” section for explanation of possible sources of background vibration.

### Limit

The Balance Limit represents the best balance achievable, and is the target vibration level during a balance cycle. It is factory set at 0.4 microns displacement. A balance Limit of 1.0 micron or less is generally considered adequate for most applications. The Limit should be set at least 0.2 microns higher than the highest background vibration level noted in the “Background Vibration” section. Some experience may be necessary to determine the appropriate balance Limit for a particular installation.



**NO BALANCE SYSTEM IS CAPABLE OF BALANCING THE GRINDING WHEEL TO A VALUE BELOW THE BACKGROUND LEVEL.** Trying to set the balance Limit below background levels will result in failed balance cycles. Since the background vibration level is often a product of floor transmitted vibrations, these levels may change as adjacent machines are put into or out of service. **Set the balance Limit during periods when the system will receive the maximum floor transmitted vibration.**

### Tolerance

This setting establishes an upper-limit for normal process vibration for the grinder. When vibration reaches this level, the control will indicate the need to perform a balance cycle. Indications given on the front panel for balance status are shown, and additional indication is given on the Hardwire Interface. The Tolerance level is typically it is set at least 1 micron above Limit setting.

### Critical Vibration

This setting establishes an operational upper safety limit of vibration for the system. When reached, this setting will cause an indication of the critical need to perform a re-balance operation. This indication on the front panel is shown, and additional indication is given on the Hardwire Interface. The Critical level is typically set **at least** 5 microns above the Tolerance setting.

## Operation Overview

### Navigation and Edit Conventions

The following screens show the conventions in operation throughout the menu structure of the SB-2000.

- A yellow outline is used to indicate which option is currently selected. Most settings are represented by symbols that indicate the available options for that setting. Some settings require a number to be set.
- Current saved settings are shown as either a symbol highlighted with a white background, or by the displayed number for the setting.
- Use the arrow keys to move from one setting to the next. The yellow outline will indicate the current selection.
- Press the OK button to activate editing of the selected option. Press  Cancel to exit.

### **When in edit mode:**

- A yellow highlighted background is used to show the current item or number being edited.
- The OK symbol will flash in yellow at the left side of the screen whenever the current selection is different than saved settings. This indicates that pressing OK is required to save the new current settings.
- The Arrow buttons are used to make selections, and also to make edit numbers. Where a number needs to be entered, the ◀ ▶ buttons are used to select the digit to be changed (move the underline). The ▲ and ▼ buttons increment or decrement the number at the underlined digit. Holding the arrow button will start an accelerating repetition of the button press.
- Pressing OK will save changes made. Pressing  Cancel will discard changes made and revert to the previously saved data.

## Multiple Machine Operation

If desired, setup parameters & balance solutions can be stored for more than one machine. Enabling this feature requires the activation of multiple machine mode.

When in multiple machine mode, the control saves independent setup information for up to thirty-four machines using a machine ID number of 01-34. This is useful where the control will be moved between machines with different setup requirements. It is recommended that the grinding machines in such a scenario be labeled with the appropriate machine ID number for reference.

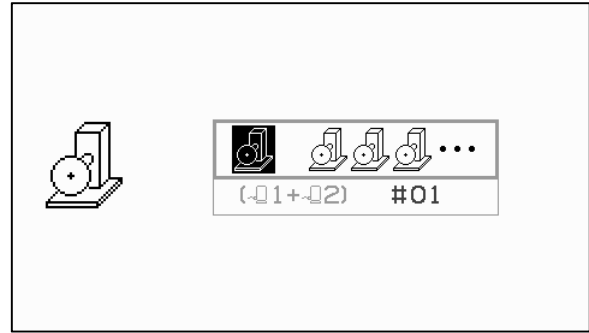

**Access the Machine Mode screen by pressing and holding the Setup  button.** The first icon in the top section of the screen selects single machine operation, and the second icon selects multiple machine operation.

When multiple machine operation is active, the selection screen is shown every time the unit powers on so the user can match control to the ID of the machine. The screen shown indicates that machine 12 is selected. As this number is edited, the graphic next to it indicates if the selected machine ID is currently setup for use with a particular vibration sensor ( -01 or -02 or both). Where no balance setup information is saved under a machine ID number, then this area on screen will be empty ( - ). This indicates an available or unused ID.

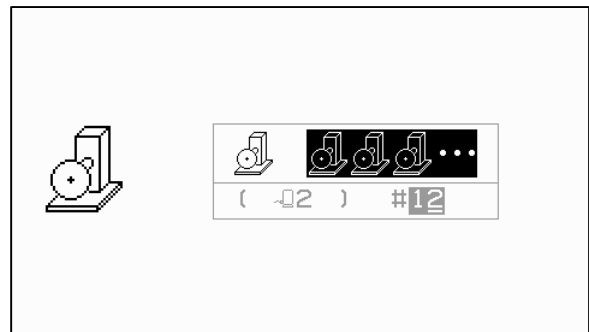

Machine Selection Power Up Screen

Use the arrow buttons to change the machine number selected. Press OK to accept the current selection and go to the Main screen.

The machine ID is displayed in a box at the top of the screen during normal operation as an indicator of the selection made.

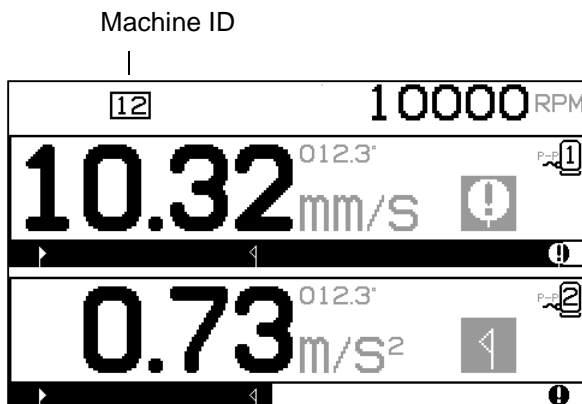

## Balance Process

### Setup

There are a number of user selectable operating settings for the SB-2000, which are found under the Setup menu. Press the  button to enter this menu and display setup screen 1 shown. This setup screen provides settings for the machine or job as a whole.

Press the  button a second time to display setup screen 2, with sensor specific settings. This setup screen shows the sensor number being edited.

When dual plane  operation is selected, the setup screen 2 will be duplicated for each of the two sensors, allowing separate settings for each.

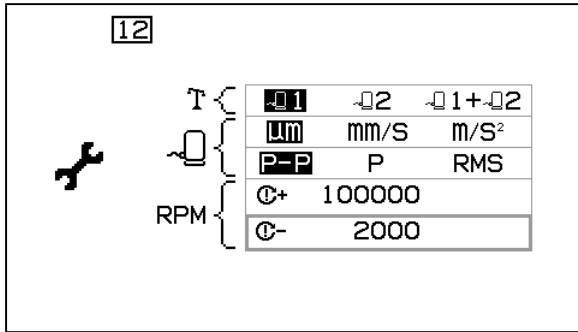

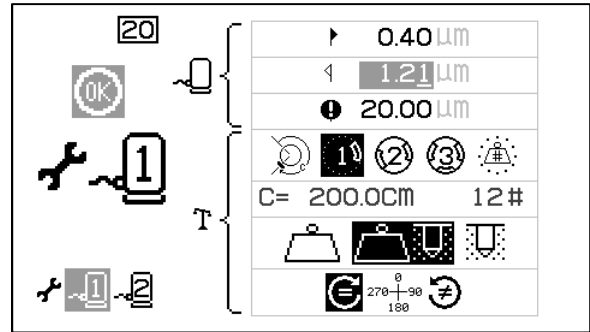

Setup Screen 1











Setup Screen 2

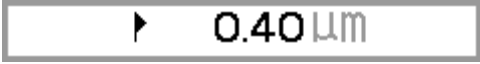
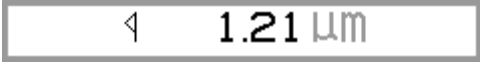







When the SB-2000 is in the setup menu, the  symbol is displayed on the left side of the screen. When in multiple machine mode, the current machine number is displayed in the box at top of the screen. The Setup menu will time out after 1 minute of inactivity and the unit will return to the Main screen without saving any changes. The hardware interface output relays will remain active during setup.

Each of the following settings is presented in order under the setup menu.

Setup Screen 1 – Machine/Job Assigned Settings	
	Sensor Selection. Select the sensor(s) active for the current job.
	Vibration Display Units.
	Vibration Type. P-P = Peak to Peak measurement P = Peak measurement (0.5*P-P) RMS = RMS Average measurement (.707*P)
	Critical RPM Limit. Setting a value of zero disables this option. If RPM is measured above the set Critical RPM Limit, then the  error is indicated on the display, and BOT2 relay is activated on the Hardwire Interface.
	Minimum RPM Setting. Setting a value of zero sets the threshold to the lowest detectable RPM. If RPM is measured below the Minimum RPM Limit, then the  error is indicated on the display, and SIR relay is open on the Hardwire Interface.

Setup Screen 2 – Sensor Assigned Settings

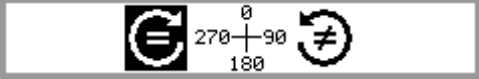
	<p><b>Balance Limit.</b> The SBS Balance System will attempt to balance to this user specified lowest possible vibration level. The Limit represents the best balance achievable, and is the target vibration level during the balance process. It is factory set at 0.4 microns displacement. A balance Limit of 1.0 micron or less is generally considered adequate for most applications. The Limit should be set at least 0.2 microns higher than the highest background vibration level noted in the “Preparing to Set Operating Parameters” section. Some experience may be necessary to determine the appropriate balance Limit for a particular installation.</p>
	<p><b>Tolerance.</b> This setting establishes an upper limit for normal process vibration for the grinder. When vibration reaches this level, The control will indicate the need to perform a balance process. Indication is given on the screen and on the Hardware Interface. The Tolerance level is typically set <u>at least</u> 1 micron above Limit setting.</p>
	<p><b>Critical Vibration.</b> This setting establishes an operational safety limit of vibration for the system. When reached, this setting will cause an indication of the critical need to perform a re-balance operation. This indication is given on the display and the Hardware Interface. The Critical level is typically set <u>at least</u> 5 microns above the Tolerance setting.</p>
	<p><b>Balance Type.</b> Each type describes the method of balancing weight attachment to be used on the machine to perform balancing.</p> <ul style="list-style-type: none"> <li> <b>Circumferential Weight</b> – One weight of variable mass is positioned at a distance around the circumference of a rotor.</li> <li> <b>Single Weight</b> – One weight of variable mass is positioned at an angle.</li> <li> <b>Two Weights</b> – Two equal, fixed mass weights are positioned at variable angle positions.</li> <li> <b>Three Weights</b> – Three equal, fixed mass weights are positioned at variable angle positions.</li> <li> <b>Fixed Positions</b> – A specified number of mounting positions in an equally spaced fixed pattern (such as a bolt circle) are available for adding variable mass weights.</li> </ul>
	<p>If Fixed Position Balance Type is selected, then the right side of the following selection is displayed. This allows for editing the number of fixed positions from 3 to 99, in order to identify the available positions during balancing. The positions are assumed to be evenly spaced in a 360 degree pattern. They must be labeled on the machine from 1 to the highest number available.</p>

	<p>If Circumferential Weight is selected, then the left side of this selection is displayed. This allows for editing the circumference of the rotor around which the user will measure the distance to place a balance weight.</p>
	<p>Drill mode selection is only available when one of the two single point balance modes has been selected,  or . A sub-menu is presented for selecting:</p> <p> Add Weight mode for each balance phase.</p> <p> Drill (Remove Material) mode for each balance phase.</p> <p> The middle setting allows the test weight to be added and the final balance solution to be performed by <u>removing</u> the test weight and then using the drill method. In this mode the test weight screen is the same as for the add weight only mode.</p>
	<p>Scale Direction. Sets the direction of the scale used to position the balance weights relative to the wheel's direction of rotation. The weight scale direction is the direction in which the angle references (0°, 90°, 180° etc.) or the weight position location numbers (1,2,3,4, etc.) <b>increase</b>.</p> <p> Spindle rotation is in the <u>same</u> direction as the weight scale.</p> <p> Spindle rotation is in the <u>opposite</u> direction as the weight scale.</p>

## Balance Process Overview

Press **T** Balance to start a complete Manual Balance operation. There are a minimum of three phases for each balancing cycle:

1. **Initial Phase.** The vibration level is measured and saved.
2. **Test Phase.** A test weight is placed on the machine so its effect can be measured.
3. **Solution Phase.** The balancing solution is provided. The correction weight is placed on the machine & the results are measured.

If the resulting vibration is below the Balance Limit **▶** the balance process will complete and exit to the main screen. If the resulting vibration is above the Balance Limit, a new balance solution will be provided to correct for the residual unbalance. Every subsequent balance solution is a **Trim Phase**. A Trim phase is just an iteration of the Solution Phase, performed if more adjustment is needed.

Each Phase has four parts:

- a. Stop spindle. The control indicates that the spindle needs to stop.
- b. Apply weights. Once stopped the operator must configure the weights as instructed.
- c. Start Spindle. The spindle must be started.
- d. Measure. The vibration can be measured for calculating the next phase.

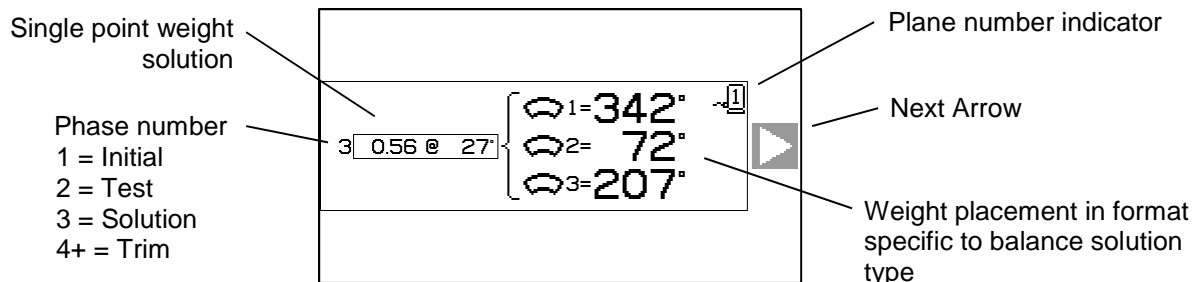

This information is remembered through a power cycle. The hardwire interface output relays will remain active during the balance operation. Except where noted, the **⊗** Cancel button will stop the balance operation and return to the main screen.

## Trim Balance

The first two phases of the balance cycle (Initial and Test) allow the SB-2000 to determine and save essential information regarding the condition of the grinder and how changes in balance weights will effect machine balance. Assuming the conditions on the machine do not change (RPM, wheel size, etc.) then subsequent balance operations can be successfully performed without re-running these two phases. If machine conditions do change, then performing balance operations based on the saved results of the Initial and Test phases will produce inaccurate results.

Trim balancing can be performed at any time that vibration levels rise above a satisfactory balance condition. Press the **T** Trim button to start a Trim Balance operation. This skips the Initial and Test phases of the operation and starts at the Solution phase. To do this the SB-2000 must have saved results from a previously completed Initial phase and Test phase. If the **T** Trim button is pressed when these two phases have not been completed, then the **⊗** FPI indication will display for 1.5 second, and the Solutions screen will not be displayed. The **T** Trim will only operate if the spindle is running within 3% of the RPM of the Test phase.

**Balancing Problems** - If successive Trim balance attempts are unsuccessful, this is an indication that either machine conditions have changed, or an error has occurred in weight placement (inaccurate position(s) or mass changes). In this case the operator should verify the Scale Direction setting is still accurate, then press **T** to start a new complete Manual Balance operation.

**Important** - Performing a Manual Balance will only be successful if the user is very careful in following each step of the process, and making certain that weight movements and additions are performed accurately. Both the mass of weight used and the positioning of weights used will determine the accuracy of the balance achieved.

### Dual Plane Balance

Sections follow to describe the operation of the different balancing types. For simplicity, the screens shown are for single plane balancing. The phases for two-plane balancing are identical, but weight placement screens and measure vibration screens will show information for each of the two planes, with the top of the screen indicating plane1 and the bottom of the screen indicating plane 2.

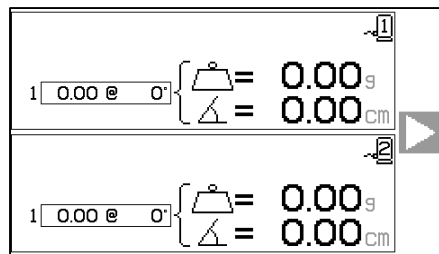

Weight placement

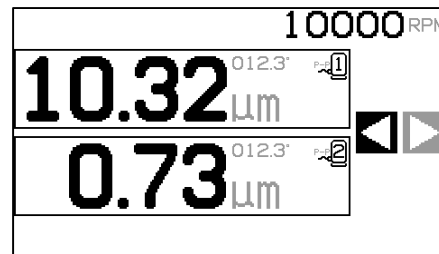





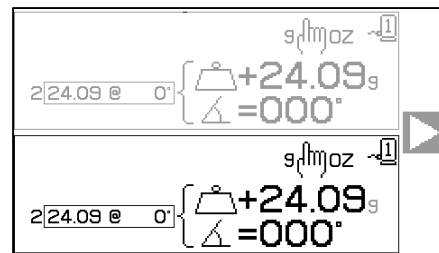
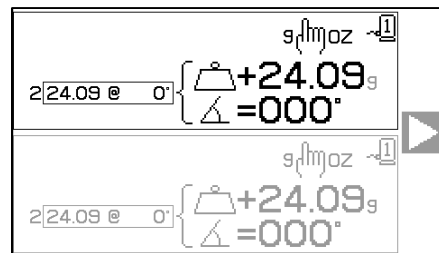



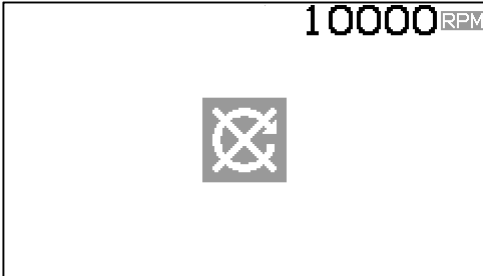

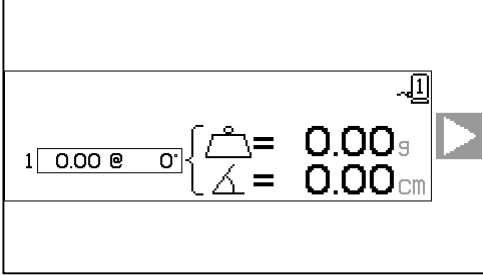

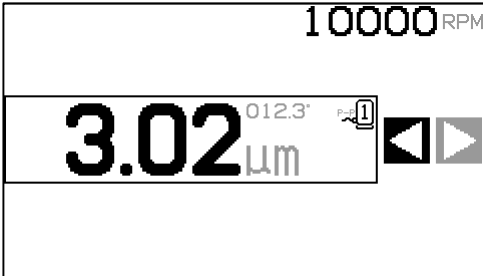

Measure Vibration

The test weight placement phase is broken into two separate steps, with one weight placement for each plane. The screen will show one plane as active, with the other plane shown greyed out. Complete each of the weight placements in sequence as directed.

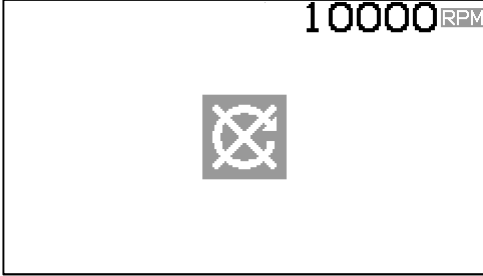

 Circumferential Weight Balance Process

 	<p style="text-align: center;"><b>Initial</b></p> <hr/> <p>Stop Spindle - This screen requests the operator to stop the spindle. The  Stop Spindle icon flashes as a reminder. This screen stays until the control detects that the spindle rotation has stopped.</p>
 	<p style="text-align: center;"><b>Initial</b></p> <hr/> <p>Apply Weights - Once the spindle is stopped, this screen shows the operator how to place the weight. During the Initial Phase there should be no weight placed on the machine.</p> <p>Press  to indicate that the machine is ready.</p>
 	<p style="text-align: center;"><b>Initial</b></p> <hr/> <p>Start Spindle - This screen prompts you to start the spindle so a vibration measurement can be taken. The  icon and the “RPM” both flash as a reminder. The control stays on this screen until it senses the spindle is up to constant speed. Then the screen advances to the Measure screen.</p> <p>The Back arrow on the screen indicates that pressing  will return you to the Apply Weights screen.</p>
 	<p style="text-align: center;"><b>Initial</b></p> <hr/> <p>Measure Vibration - Once the rpm has stabilized, the Next arrow will appear on the screen and flash. Pressing  will store this measurement into memory.</p> <p>The Back arrow on the screen indicates that pressing  will return you to the Apply Weights screen.</p>
 	<p style="text-align: center;"><b>Test</b></p> <hr/> <p>Stop Spindle - The  Stop Spindle icon flashes as a reminder to stop the spindle.</p>



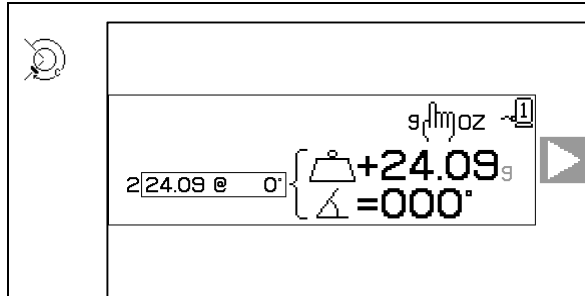

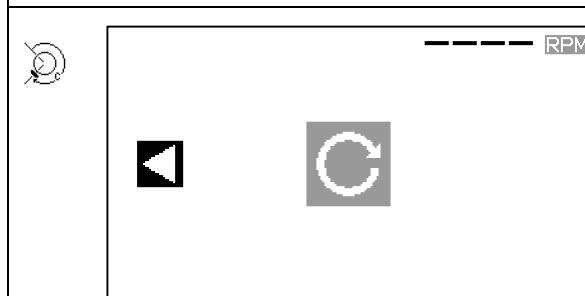
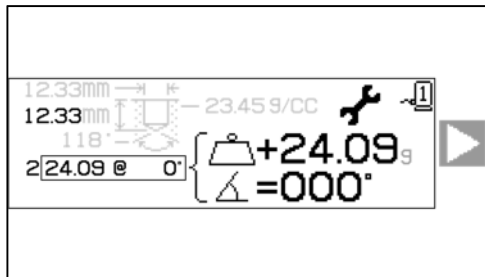

When  mode is active:





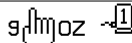

### Test

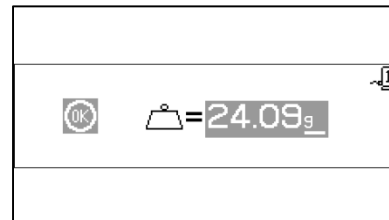
Apply Weights (or drill if  is selected) – The test weight shown on the screen must be added (or drilled) at the zero position. The value of the test weight is shown.

During the Test Phase pressing the Edit Button  (note  icon) will display this screen, allowing the test weight mass value to be edited. The weight units can also be selected from g, oz, lb, kg, and none. Changing units does not convert mass value.



When done editing press OK to save changes and return to the Apply Weights screen.

When  mode is active, the  button allows selection and edit of drill parameters as well as the weight mass value. Drill parameters are shown at upper left of screen (density, drill angle, drill Ø, and drill depth). Press   to highlight which field to edit.

Press OK to edit the selected parameter, and then use the arrow buttons to change values. Press OK again to save changes. As changes are made, the other related parameters will update on screen. Press Cancel to exit edit and return to balance process.

Press  to indicate that the machine is ready.

### Test

Start Spindle - The  icon and the “RPM” both flash as a reminder to start the spindle again.

The Back arrow on the screen indicates that pressing  will return you to the Apply Weights screen.

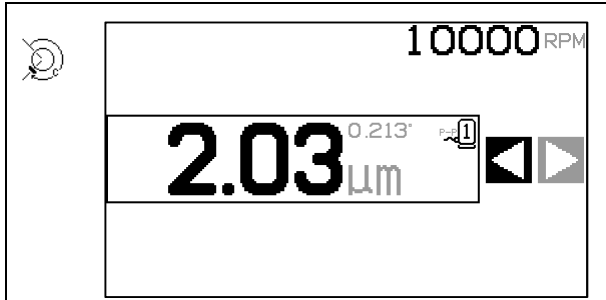

**Test**

Measure Vibration - Once the rpm has stabilized, the next arrow will appear on the screen and flash. Pressing ► will store this measurement into memory.

The Back arrow on the screen indicates that pressing ◀ will return you to the Apply Weights screen.

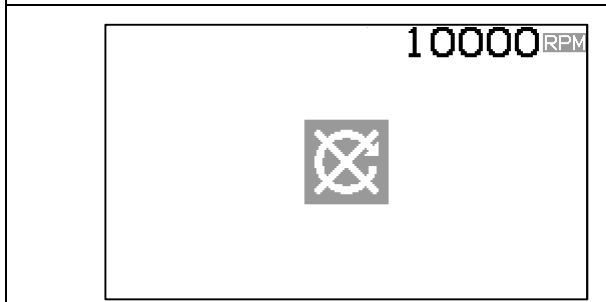

**Solution**

Stop Spindle - The ⓧ Stop Spindle icon flashes as a reminder to stop the spindle.

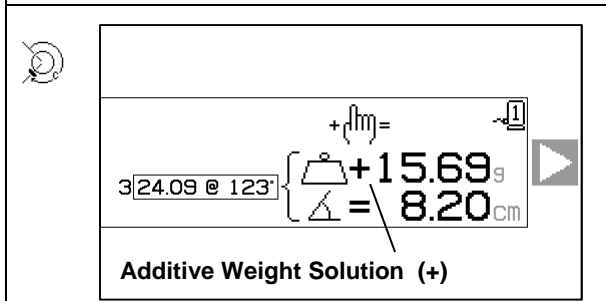

**Solution**

Apply Weights (drill if ⓧ is selected) - The weight should be changed (or drilled) at the position and mass shown to bring the balance to a minimum.

**Place balance weights on same radius as the test weight.**

**There are two ways to display the solution:**

**Additive or Absolute**

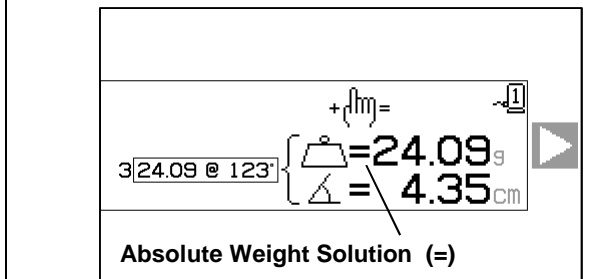

Press ⓧ to Toggle between Additive and Absolute Weight Solution screens. (note +ⓧ= icon on solution screen).

**Additive Solution (+)**  
Leave all existing weights on the machine and add what is shown.

**Absolute Solution (=)**  
Remove all test weights first then place weights as shown.

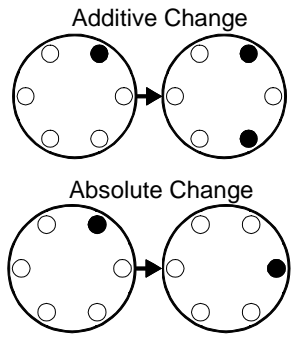



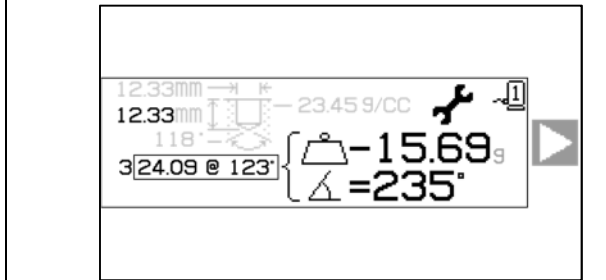



When ⓧ mode is active:



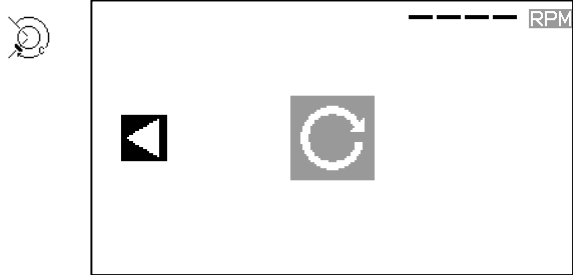

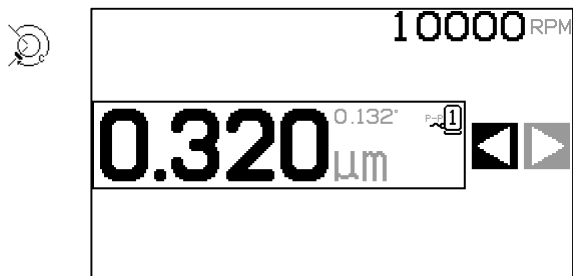

When ⓧ mode is active, the ⚙ button allows selection and edit of drill parameters only. Drill parameters are shown at upper left of screen (drill angle, drill Ø, and drill depth). Press ◀ ► to highlight which field to edit.

Press OK to edit the selected parameter, and then use the arrow buttons to change values. Press OK again to save changes. As changes are made, the other related parameters will update on screen. Press Cancel to exit edit and return to balance process.



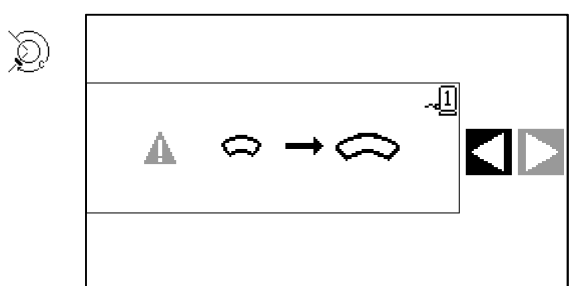

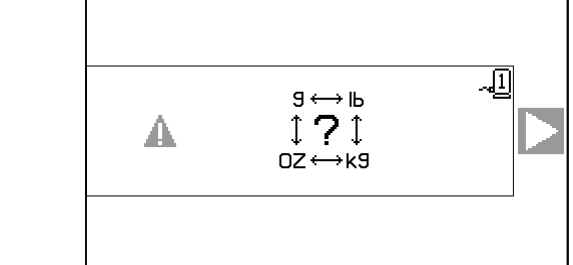



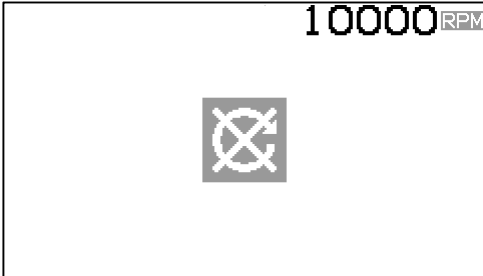

Press the next button ► to indicate that the machine is ready.

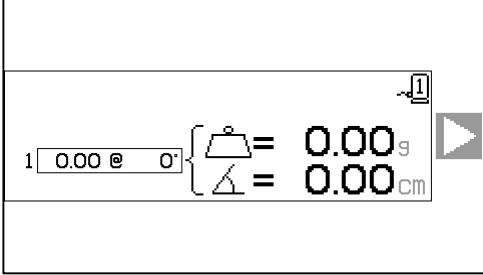
	<p style="text-align: right;"><b>Solution</b></p> <p>Start Spindle - The  icon and the “RPM” both flash as a reminder to start the spindle again.</p> <p>The Back arrow on the screen indicates that  will return you to the Apply Weights screen.</p>
	<p style="text-align: right;"><b>Solution</b></p> <p>Measure Vibration. Once the rpm has stabilized, the right arrow will appear on the screen and flash. Pressing the next button  will store this measurement into memory.</p> <p>The Back arrow on the screen indicates that  will return you to the Apply Weights screen.</p> <p>If the resulting vibration is below the Balance Limit  the balance process will complete and exit to the main screen. If the resulting vibration is above the Balance Limit, a new balance solution will be provided to correct for the residual unbalance.</p>

Every subsequent balance solution is a **Trim Balance**. A Trim balance is just another iteration of the Solution Phase, performed if more adjustment is needed.

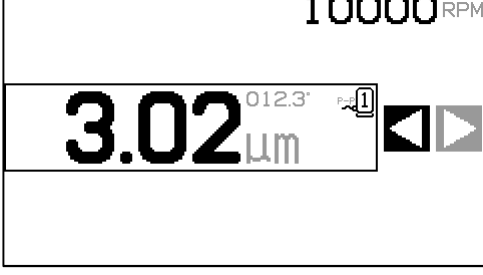
	<p>One of these screens may be displayed instead of the Solution screen if the Balance Solution is difficult to achieve.</p> <p>The top screen shown indicates that bigger weights should be used. Press  button to return to Apply Weights screen for an opportunity to use a larger weight and repeat the Test phase.</p>
	<p>The bottom shown screen indicates that the compensation numbers are very large or small for accurate display and the weight units in use may need to change. Press  button to return to the Apply Weights screen without making any changes.</p> <p>If changes are made, a new complete balance operation should be run by pressing .</p>

## 10 Single Point Balance Process

<p>10</p> 	<p><b>Initial</b></p> <p>Stop Spindle - This screen requests the operator to stop the spindle. The  Stop Spindle icon flashes as a reminder. This screen stays until the control detects that the spindle rotation has stopped.</p>
<p>10</p> 	<p><b>Initial</b></p> <p>Apply Weights - Once the spindle is stopped, this screen shows the operator how to place the weight. During the Initial Phase there should be no weight placed on the machine.</p> <p>Press  to indicate that the machine is ready.</p>
<p>10</p> 	<p><b>Initial</b></p> <p>Start Spindle - This screen prompts you to start the spindle so a vibration measurement can be taken. The  icon and the “RPM” both flash as a reminder. The control stays on this screen until it senses the spindle is up to constant speed. Then the screen advances to the Measure screen.</p> <p>The Back arrow on the screen indicates that pressing  will return you to the Apply Weights screen.</p>
<p>10</p> 	<p><b>Initial</b></p> <p>Measure Vibration - Once the rpm has stabilized, the Next arrow will appear on the screen and flash. Pressing  will store this measurement into memory.</p> <p>The Back arrow on the screen indicates that pressing  will return you to the Apply Weights screen.</p>
<p>10</p> 	<p><b>Test</b></p> <p>Stop Spindle - The  Stop Spindle icon flashes as a reminder to stop the spindle.</p>

10

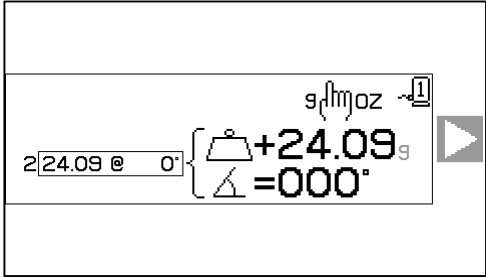

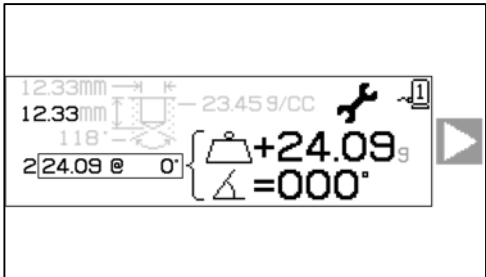

When  mode is active:





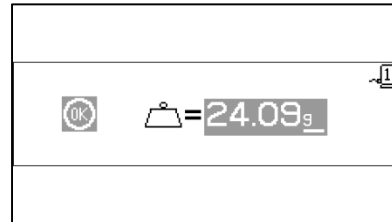

### Test

Apply Weights (or drill if  is selected) – The test weight shown on the screen must be added (or drilled) at the zero position. The value of the test weight is shown.

During the Test Phase pressing the Edit Button  (note  icon) will display this screen, allowing the test weight mass value to be edited. The weight units can also be selected from g, oz, lb, kg, and none. Changing units does not convert mass value.



When done editing press OK to save changes and return to the Apply Weights screen.

When  mode is active, the  button allows selection and edit of drill parameters as well as the weight mass value. Drill parameters are shown at upper left of screen (density, drill angle, drill Ø, and drill depth). Press   to highlight which field to edit.

Press OK to edit the selected parameter, and then use the arrow buttons to change values. Press OK again to save changes. As changes are made, the other related parameters will update on screen. Press Cancel to exit edit and return to balance process.

Press  to indicate that the machine is ready.

10

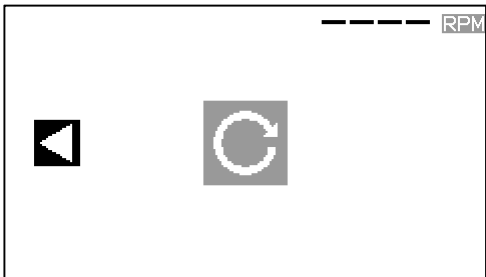

### Test

Start Spindle - The  icon and the “RPM” both flash as a reminder to start the spindle again.

The Back arrow on the screen indicates that pressing  will return you to the Apply Weights screen.

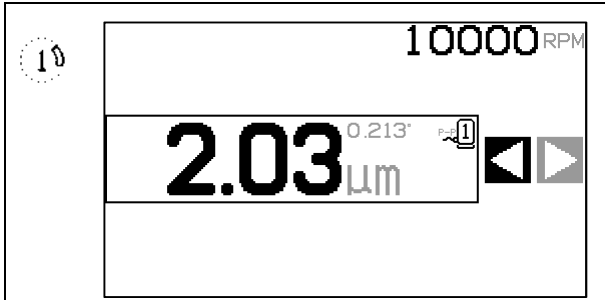

**Test**

Measure Vibration - Once the rpm has stabilized, the next arrow will appear on the screen and flash. Pressing ► will store this measurement into memory.

The Back arrow on the screen indicates that pressing ◀ will return you to the Apply Weights screen.

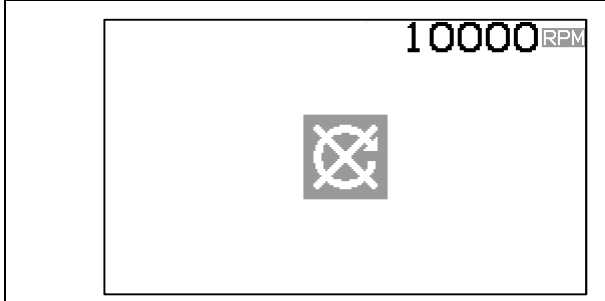

**Solution**

Stop Spindle - The ⓧ Stop Spindle icon flashes as a reminder to stop the spindle.

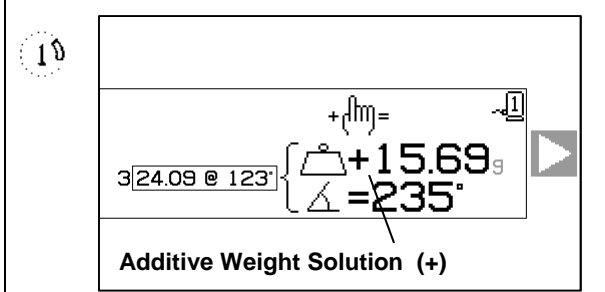

**Solution**



Apply Weights (drill if  is selected) - The weight should be changed (or drilled) at the position and mass shown to bring the balance to a minimum.

**Place balance weights on same radius as the test weight.**

**There are two ways to display the solution:**

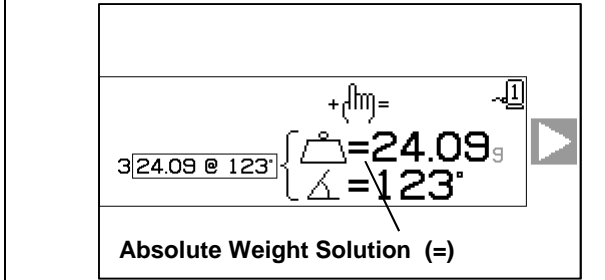
**Additive or Absolute**



Press  to Toggle between Additive and Absolute Weight Solution screens. (note +  = icon on solution screen).

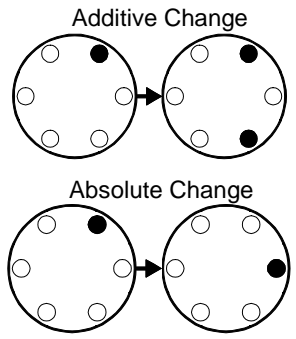

**Additive Solution (+)**  
Leave all existing weights on the machine and add what is shown.

**Absolute Solution (=)**  
Remove all test weights first then place weights as shown.



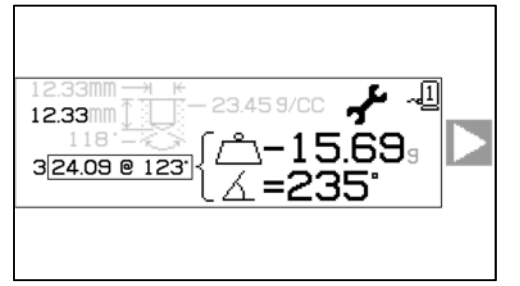





When  mode is active:



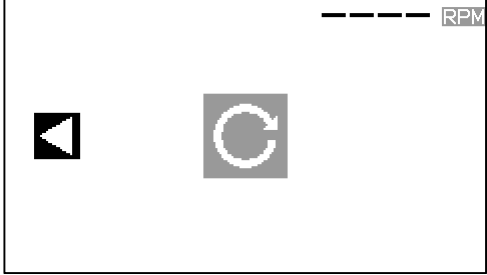

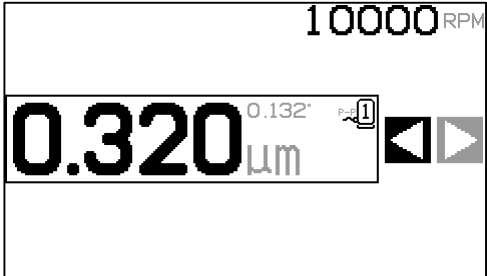

When  mode is active, the  button allows selection and edit of drill parameters only. Drill parameters are shown at upper left of screen (drill angle, drill Ø, and drill depth). Press ◀ ► to highlight which field to edit.

Press OK to edit the selected parameter, and then use the arrow buttons to change values. Press OK again to save changes. As changes are made, the other related parameters will update on screen. Press Cancel to exit edit and return to balance process.

Press the next button ► to indicate that the machine is ready.

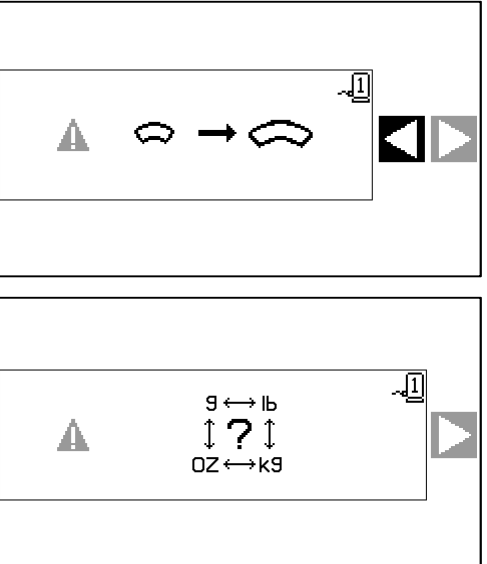





<p>10</p> 	<p style="text-align: right;"><b>Solution</b></p> <p>Start Spindle - The  icon and the “RPM” both flash as a reminder to start the spindle again.</p> <p>The Back arrow on the screen indicates that  will return you to the Apply Weights screen.</p>
<p>10</p> 	<p style="text-align: right;"><b>Solution</b></p> <p>Measure Vibration - Once the rpm has stabilized, the right arrow will appear on the screen and flash. Pressing the next button  will store this measurement into memory.</p> <p>The Back arrow on the screen indicates that  will return you to the Apply Weights screen.</p> <p>If the resulting vibration is below the Balance Limit  the balance process will complete and exit to the main screen. If the resulting vibration is above the Balance Limit, a new balance solution will be provided to correct for the residual unbalance.</p>

Every subsequent balance solution is a **Trim Balance**. A Trim balance is just another iteration of the Solution Phase, performed if more adjustment is needed.

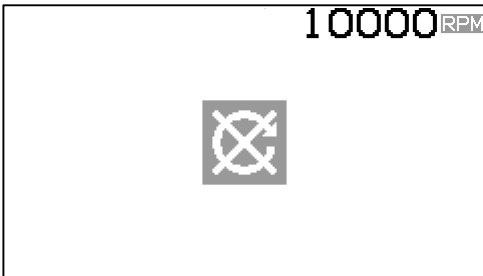

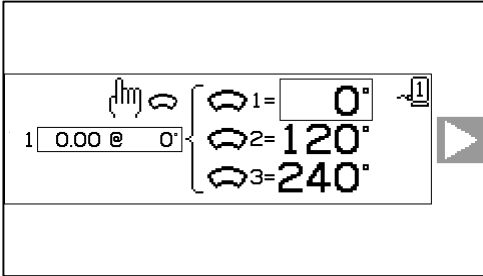

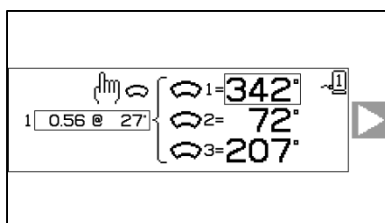

<p>10</p> 	<p>One of these screens may be displayed instead of the Solution screen if the Balance Solution is difficult to achieve.</p> <p>The top screen shown indicates that bigger weights should be used. Press  button to return to Apply Weights screen for an opportunity to use a larger weight and repeat the Test phase.</p> <p>The bottom shown screen indicates that the compensation numbers are very large or small for accurate display and the weight units in use may need to change. Press  button to return to the Apply Weights screen without making any changes.</p> <p>If changes are made, a new complete balance operation should be run by pressing .</p>
---	---

## ②③ 2 and 3 Weight Balance Process

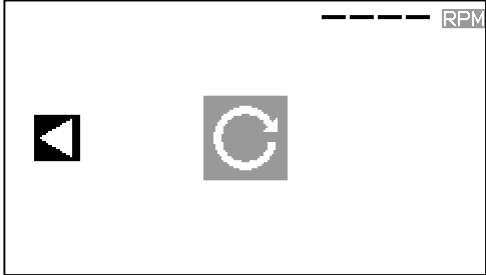
Screens shown are for 3-weight balance, but the same process applies to 2-weight balance.

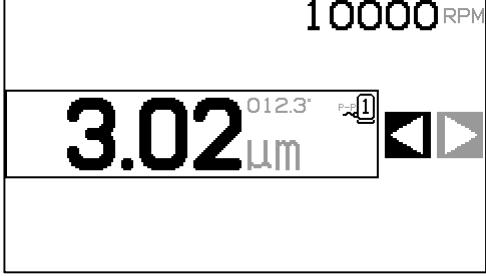
<p>②</p> <p>③</p> 	<p><b>Initial</b></p> <p>Stop Spindle - This screen requests the operator to stop the spindle. The  Stop Spindle icon flashes as a reminder. This screen stays until the control detects that the spindle rotation has stopped.</p>
<p>②</p> <p>③</p> 	<p><b>Initial</b></p> <p>Apply Weights - Once the spindle is stopped, this screen shows the operator where to position the weights. During this phase, the weights should be removed or moved to the null positions shown.</p> <hr/> <p>During the Initial Phase the  toggle icon will be displayed to indicate that the last weight positions were saved. Pressing the Toggle  Button will display and use the saved weight positions for the selected machine number. This allows a balance cycle to be performed at a low RPM, and the results of that cycle to become the Initial run start point for another balance cycle at a higher RPM.</p>  <p>Press  again to toggle back to the default null weight positions.</p> <p>Also during the Initial Phase the weight angles can be manually edited to match the existing positions of the weights. A rectangle highlights the current selection. Use the Up and Down arrows to select the angle to edit and press OK to edit the angle value. Once a value is updated, the Toggle icon will be erased and Toggle will no longer function.</p> <hr/> <p>Press  to indicate that the machine is ready.</p>

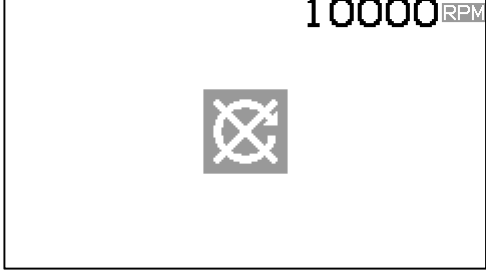

<p>②</p> <p>③</p> 	<p><b>Initial</b></p> <p>Start Spindle - This screen prompts you to start the spindle so a vibration measurement can be taken. The  icon and the “RPM” both flash as a reminder. The control stays on this screen until it senses the spindle is up to constant speed. Then the screen advances to the Measure screen.</p> <p>The Back arrow on the screen indicates that pressing  will return you to the Apply Weights screen.</p>
<p>②</p> <p>③</p> 	<p><b>Initial</b></p> <p>Measure Vibration - Once the rpm has stabilized, the Next arrow will appear on the screen and flash. Pressing  will store this measurement into memory.</p> <p>The Back arrow on the screen indicates that pressing  will return you to the Apply Weights screen.</p>
<p>②</p> <p>③</p> 	<p><b>Test</b></p> <p>Stop Spindle - The  Stop Spindle icon flashes as a reminder to stop the spindle.</p>

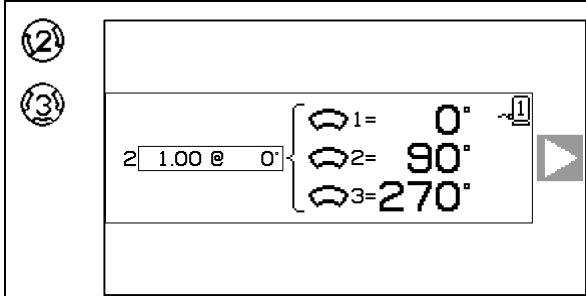

**Test**

Apply Weights - Once the spindle is stopped, this screen shows the operator where to position the weights. During this phase, one weight should be placed at the zero position or all weights moved to the positions shown.

During the Test Phase pressing the Edit Button (note icon) displays this screen, allowing editing of the test weight compensation.

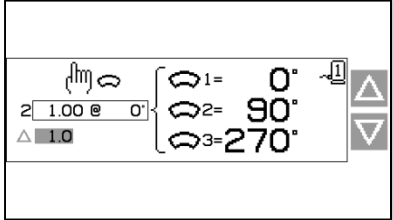

Pressing buttons will edit the highlighted test weight compensation from the default maximum of 1.0 to a minimum of 0.1, in 0.1 increments. During editing the resulting weight positions and correction vector are displayed. This allows a smaller correction vector to be used where the weights are large for the application and using the default positions would produce too large a vibration level.

When done editing press OK to save changes and return to the Apply Weights screen.

Press to indicate that the machine is ready.

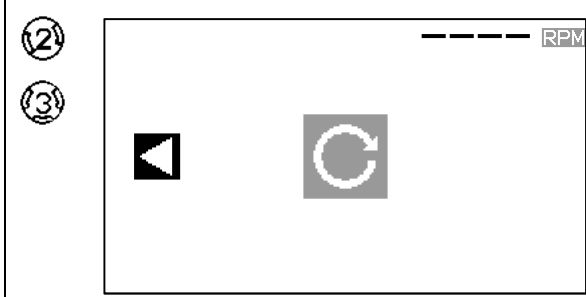

**Test**

Start Spindle - The icon and the “RPM” both flash as a reminder to start the spindle again.









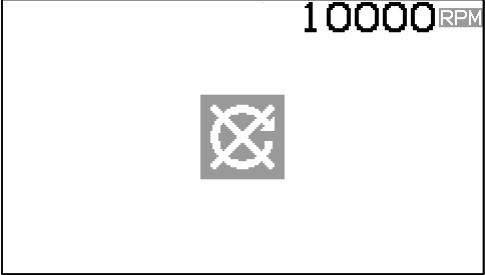

The Back arrow on the screen indicates that pressing will return you to the Apply Weights screen.

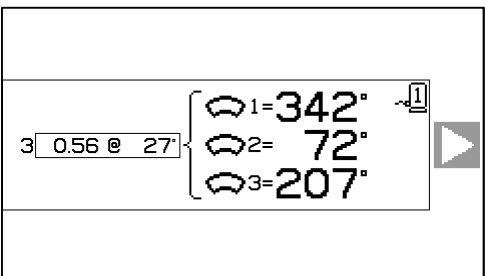

**Test**

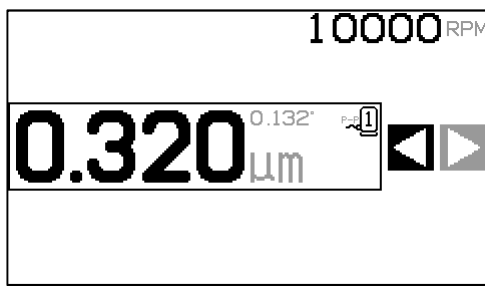
Measure Vibration - Once the rpm has stabilized, the next arrow will appear on the screen and flash. Pressing will store this measurement into memory.

The Back arrow on the screen indicates that pressing will return you to the Apply Weights screen.

<p>②</p> <p>③</p> 	<p style="text-align: right;"><b>Solution</b></p> <p>Stop Spindle - The  Stop Spindle icon flashes as a reminder to stop the spindle.</p>
<p>②</p> <p>③</p> 	<p style="text-align: right;"><b>Solution</b></p> <p>Apply Weights - The weight should be changed to the positions shown to bring the balance to a minimum.</p> <p>Press the next button  to indicate that the machine is ready.</p>
<p>②</p> <p>③</p> 	<p style="text-align: right;"><b>Solution</b></p> <p>Start Spindle - The  icon and the “RPM” both flash as a reminder to start the spindle again.</p> <p>The Back arrow on the screen indicates that  will return you to the Apply Weights screen.</p>
<p>②</p> <p>③</p> 	<p style="text-align: right;"><b>Solution</b></p> <p>Measure Vibration - Once the rpm has stabilized, the right arrow will appear on the screen and flash. Pressing the next button  will store this measurement into memory.</p> <p>The Back arrow on the screen indicates that  will return you to the Apply Weights screen.</p> <p>If the resulting vibration is below the Balance Limit  the balance process will complete and exit to the main screen. If the resulting vibration is above the Balance Limit, a new balance solution will be provided to correct for the residual unbalance.</p>

Every subsequent balance solution is a **Trim Balance**. A Trim balance is just another iteration of the Solution Phase, performed if more adjustment is needed.

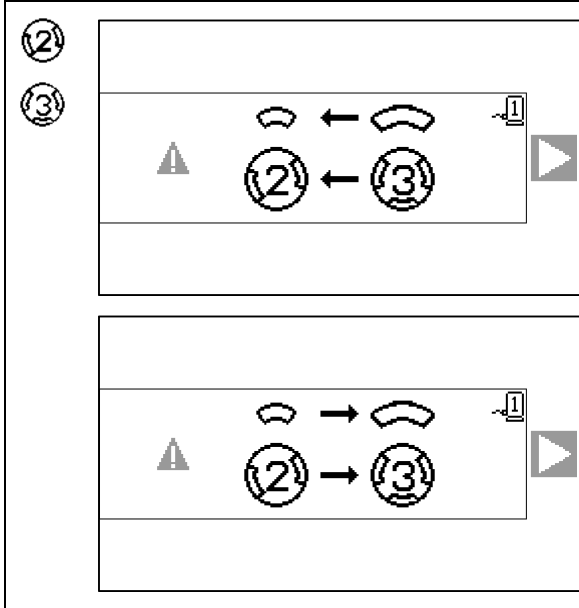













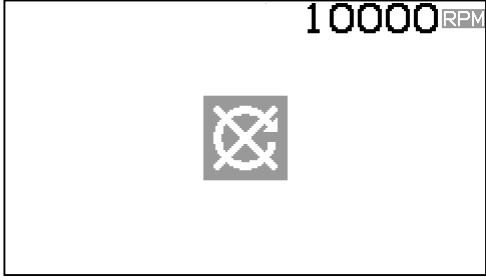

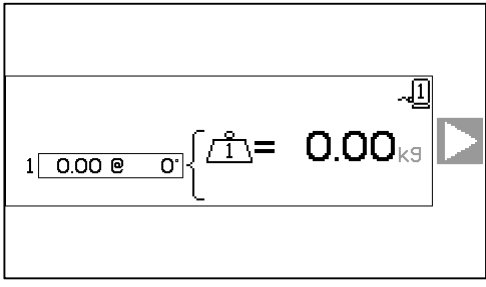

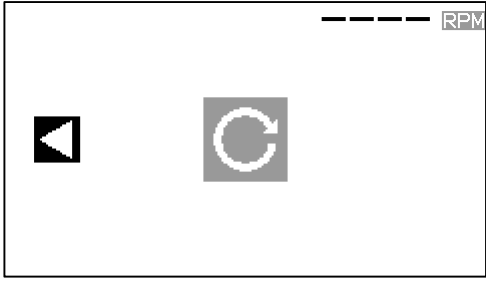
One of these screens may be displayed instead of the Solution screen if the Balance Solution is difficult to achieve.

The images depict suggestions to improve results by increasing or decreasing the weight and/or changing the balance type between two and three weights.

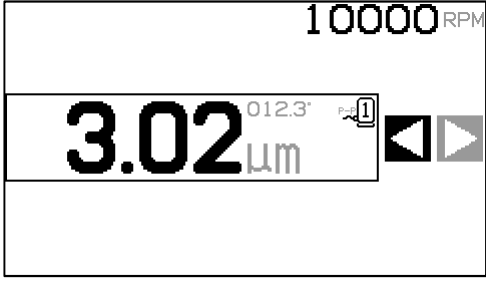
Press ► button to return to the Apply Weights screen without making any changes.

If changes are made, a new complete balance operation should be run by pressing T.

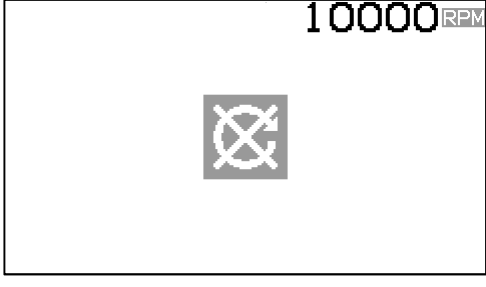
 Fixed Position Balance Process

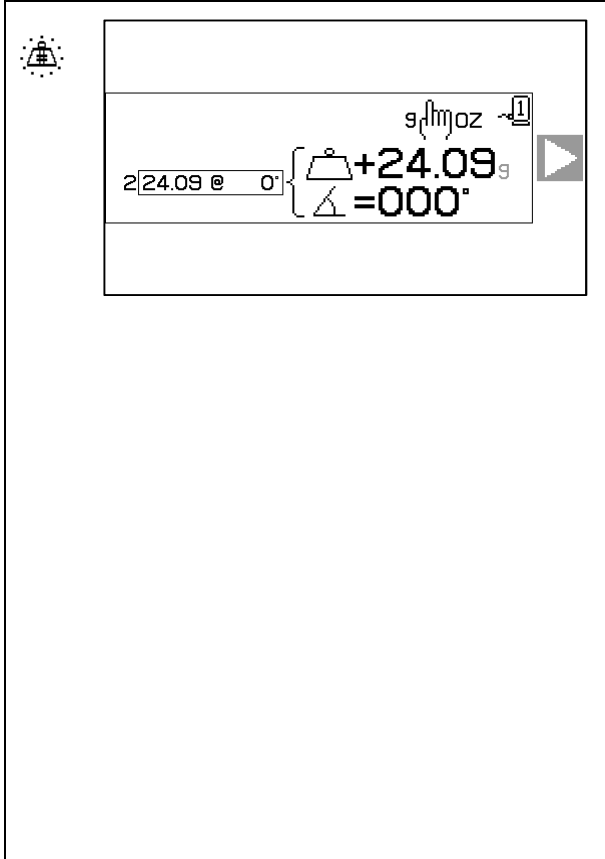

 	<p style="text-align: center;"><b>Initial</b></p> <hr/> <p>Stop Spindle - This screen requests the operator to stop the spindle. The  Stop Spindle icon flashes as a reminder. This screen stays until the control detects that the spindle rotation has stopped.</p>
 	<p style="text-align: center;"><b>Initial</b></p> <hr/> <p>Apply Weights - Once the spindle is stopped, this screen shows the operator how to place the weight. During the Initial Phase there should be no weight placed on the machine.</p> <p>Press  to indicate that the machine is ready.</p>
 	<p style="text-align: center;"><b>Initial</b></p> <hr/> <p>Start Spindle - This screen prompts you to start the spindle so a vibration measurement can be taken. The  icon and the “RPM” both flash as a reminder. The control stays on this screen until it senses the spindle is up to constant speed. Then the screen advances to the Measure screen.</p> <p>The Back arrow on the screen indicates that pressing  will return you to the Apply Weights screen.</p>
 	<p style="text-align: center;"><b>Initial</b></p> <hr/> <p>Measure Vibration - Once the rpm has stabilized, the Next arrow will appear on the screen and flash. Pressing  will store this measurement into memory.</p> <p>The Back arrow on the screen indicates that pressing  will return you to the Apply Weights screen.</p>
 	<p style="text-align: center;"><b>Test</b></p> <hr/> <p>Stop Spindle - The  Stop Spindle icon flashes as a reminder to stop the spindle.</p>



**Test**

Apply Weights - The test weight shown on the screen must be added at the zero position. The value of the test weight is shown.

---

During the Test Phase pressing the Edit Button  (note  icon) will display this screen, allowing the test weight mass value to be edited. The weight units can also be selected from g, oz, lb, kg, and none.

When done editing press OK to save changes and return to the Apply Weights screen.

---

Press  to indicate that the machine is ready.

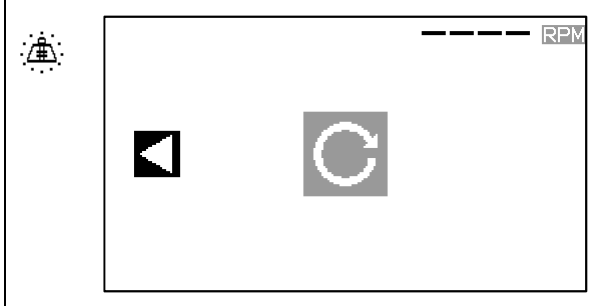

**Test**

Start Spindle - The  icon and the "RPM" both flash as a reminder to start the spindle again.

The Back arrow on the screen indicates that pressing  will return you to the Apply Weights screen.

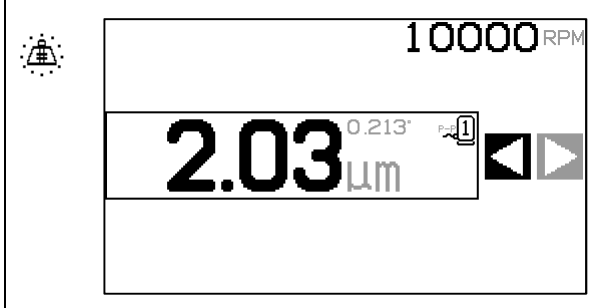

**Test**

Measure Vibration - Once the rpm has stabilized, the next arrow will appear on the screen and flash. Pressing  will store this measurement into memory.

The Back arrow on the screen indicates that pressing  will return you to the Apply Weights screen.

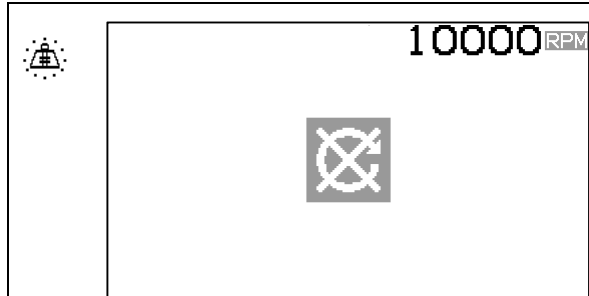

**Solution**

Stop Spindle - The  Stop Spindle icon flashes as a reminder to stop the spindle.

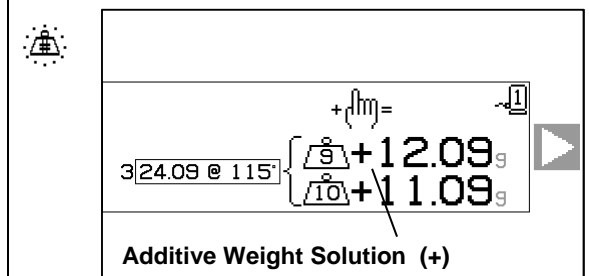



**Solution**

Apply Weights - The weight should be changed to the position and mass shown to bring the balance to a minimum.

**Place balance weights on same radius as the test weight.**

**There are two ways to display the solution:**

**Additive or Absolute**

Press  to Toggle between Additive and Absolute Weight Solution screens. (note  = icon on solution screen).

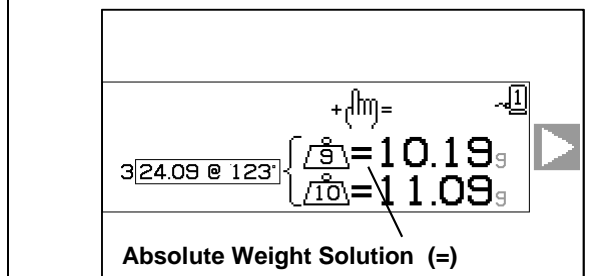

Additive Solution (+)

Leave all existing weights on the machine and only add what is shown.

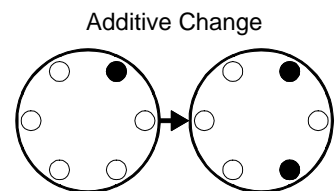

Absolute Solution (=)

Remove all test weights first then place weights as shown.

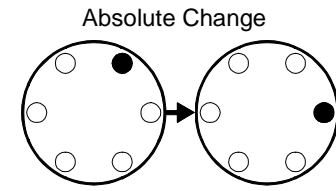

Press the next button  to indicate that the machine is ready.

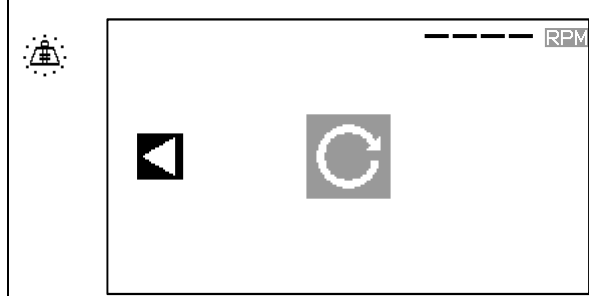

**Solution**

Start Spindle - The  icon and the "RPM" both flash as a reminder to start the spindle again.

The Back arrow on the screen indicates that  will return you to the Apply Weights screen.

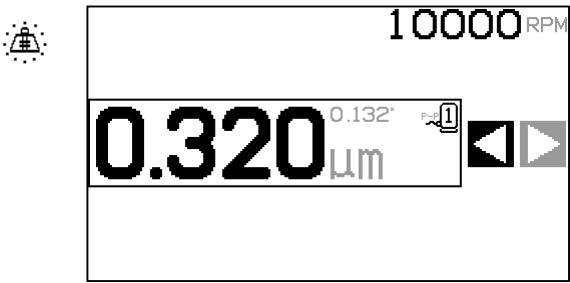
	<p style="text-align: right;"><b>Solution</b></p> <p>Measure Vibration - Once the rpm has stabilized, the right arrow will appear on the screen and flash. Pressing the next button ▶ will store this measurement into memory.</p> <p>The Back arrow on the screen indicates that ◀ will return you to the Apply Weights screen.</p> <p>If the resulting vibration is below the Balance Limit ▶ the balance process will complete and exit to the main screen. If the resulting vibration is above the Balance Limit, a new balance solution will be provided to correct for the residual unbalance.</p>
--	--

Every subsequent balance solution is a **Trim Balance**. A Trim balance is just another iteration of the Solution Phase, performed if more adjustment is needed.

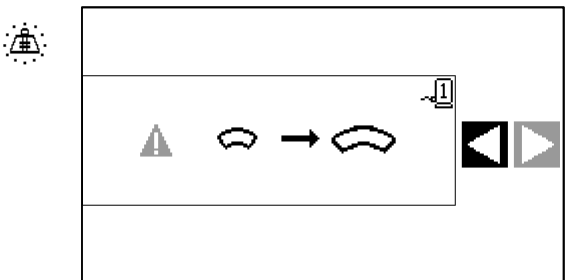
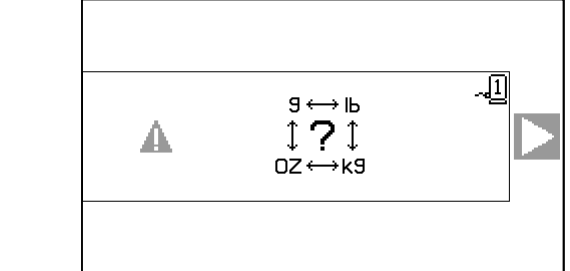
	<p>One of these screens may be displayed instead of the Solution screen if the Balance Solution is difficult to achieve.</p> <p>The top screen shown indicates that bigger weights should be used. Press ◀ button to return to Apply Weights screen for an opportunity to use a larger weight and repeat the Test phase.</p>
	<p>The bottom shown screen indicates that the compensation numbers are very large or small for accurate display and the weight units in use may need to change. Press ▶ button to return to the Apply Weights screen without making any changes.</p> <p>If changes are made, a new complete balance operation should be run by pressing T.</p>

## Plot Function

In addition to performing Balance, the SB-2000 allows vibration spectrum plots to be made and saved, as well as exported to a PC for long term reference and more detailed analysis. Press the  Plot button to display the Plot Selection screen.

### Plot Selection Screen

This screen shows an array of 34 data locations in which to save plot data. Use the arrow keys ◀ ▶ and ▲ ▼ to highlight the data location desired. The arrows at the top indicate when scrolling left or right will access more data locations. The number displayed indicates the storage location number, and is not tied to the machine number assignment. Plots are stored independent from the machine balance setup data.

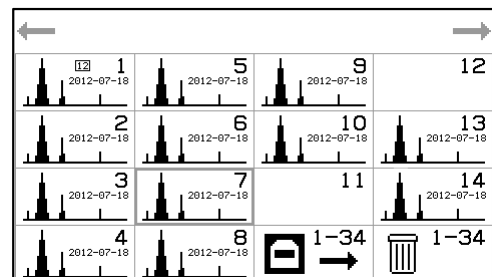





A user-defined ID text field is provided to label each saved plot. This ID text field is in date format yyyy-mm-dd, although any numbers can be used as desired in the ID text field. A plot image in the data location indicates data is stored in the location. A data location with no plot image indicates the location is empty. Press OK to activate the selected data location.

Activating a data location with a stored plot will access the Plot view screen, while activating an empty data location will display the Plot Setup screen.





At the bottom right of the Plot Selection screen are two options which effect all data locations:

- The  USB selection is used to Send All saved plot data from all data locations through the USB port. The icon will blink while this data export process is in process.
- The  Trash selection is used to Delete All stored plots from all data locations. Activating this selection is followed by a confirmation screen before plot data is erased.

Press  Cancel to return to the main screen. If a plot was measured in multi-machine mode, that machine number is displayed in the small box near the top center of its icon.

### Plot Setup Screen

This screen allows plot configuration choices to be made by the user, and for the plot process to be run.

1. Edit the ID text field as desired to label the new plot.
2. Select 1 or 2 for plotting.
3. Select  $\mu\text{m}$ , mm/s, or m/s<sup>2</sup>, vibration units.
4. Select P-P, P, or RMS amplitude type.
5. Select the starting and ending plot RPM. Time for acquisition is shown in parentheses.
6. Select  Single or  Continuous plot mode.
7. Select  Run to begin (shows the Run Plot screen).

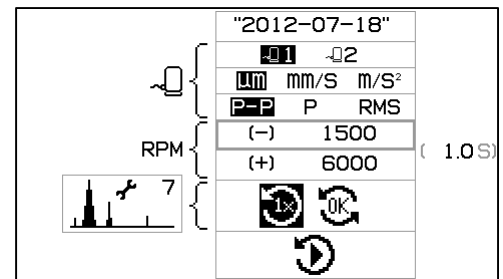

The plot configuration values default from the current data location settings where they exist, or else from:



- The last previously viewed plot's settings where they exist, or
- From the first non-empty data location's settings where they exist, or
- From the system default settings.

Press  Cancel to return to the previous screen.

### Run Plot Screen

This screen shows the progress of the plot. The bar graph shows the progress of the current plot run, while the graph shows the results of the most recently completed plot run. The peak amplitude is shown with its RPM.

In  Single Plot mode only one plot will be run, and then display the Plot View Screen.

In  Continuous Plot mode, repeated iterations of the plot will run until the user presses the OK button. At that time the mode will switch to Single Plot mode, the currently running plot will complete then display the Plot View Screen. Pressing  Cancel while in Continuous Plot Mode will end the current plot acquisition and display the Plot View Screen with the last fully acquired plot.

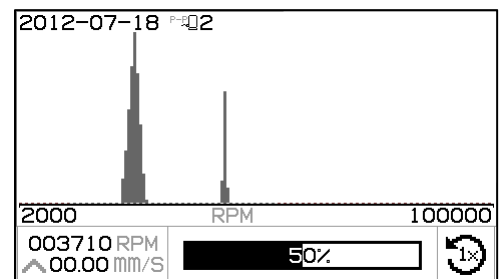

In either mode, pressing  Cancel before a plot is displayed will end the current plot acquisition without saving any new data. If no data was previously saved in the data location, then the Plot Setup will be displayed.

### Plot View Screen





This screen shows the plot data at completion of the plot process. This data is saved at plot completion.

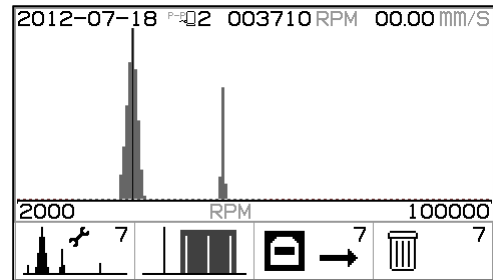

The top section of the screen displays the plot graph, including the following information:



- The user-defined ID
- Sensor number with vibration units
- Peak vibration level and its associated RPM.
- The RPM range of the plot.





The bottom section of the screen displays four icons for selecting functions which are specific to this data location:

- The plot setup icon , including the data location number. Activating this icon (pressing OK) will display the Plot Setup screen, allowing changes to the plot setup a new plot to be run for this data location.
- The harmonic cursor icon . Activating this icon (pressing OK) will toggle on/off the display of harmonic cursor in the plot graph area. This allows the user to see the vibration of the RPM marked by the cursor as well as the multiples of that frequency on the screen.
- The  USB output icon. Activating this icon (pressing OK) will output the data for the current plot.
- The  Delete icon. Activating this icon (pressing OK) will delete the data for the current plot.

Press  and  to move the highlight selection between the top and bottom sections of the screen.

With the Plot section highlighted, press  and  to move the RPM cursor. The display values will follow.

With the icon section highlighted, press  and  to move the selection highlight from icon to icon, and press OK to activate the indicated selection.

Press  Cancel to return to the Plot Selection screen.



### Delete Plot Confirmation

The first screen is displayed when  Delete is activated for a specific plot (from the Plot View screen).

The second screen is displayed when  Delete is activated for all plot data (from the Plot Selection screen).

On either screen press  Cancel or OK to exit without deleting.

To confirm  Delete action:

- Press  Left to select  Delete confirmation.
- Press OK to confirm deletion.

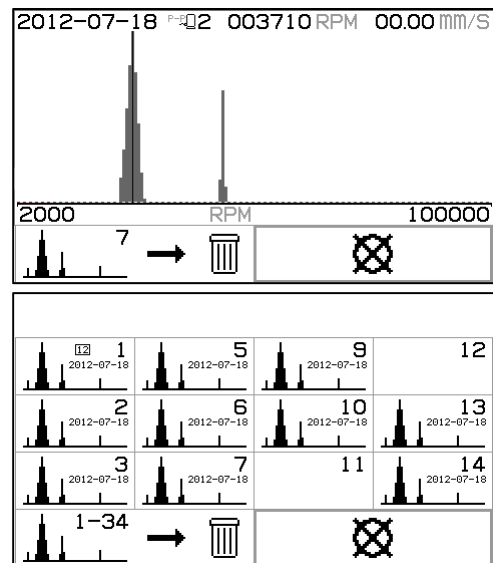

## USB Interface

The SB-2000 Balance Control provides a software interface via a Full Speed USB device. This interface allows for firmware flash update of the control, or for export of Plot data to a connected PC.

### Interfacing

The interface is a serial interface emulation which connects the Control to a Windows computer over USB. When connecting via USB, Windows will assign a COM port to the control. If the SB-2000 is not automatically assigned a COM port, a driver for Windows installation of USB-Serial communication is available on the SBS website at [www.sbs.schmitt-ind.com](http://www.sbs.schmitt-ind.com). COM port assignment is controlled by Windows. The port assigned can be determined by viewing Windows Device Manager. Use HyperTerminal or other serial communications software to interact with the Control over USB connection.

U(uu:aa,n,id)	This is the header line generated when the operator requests the plot data export from the keypad. 'uu' is units (um, mm/s, or m/ss), 'aa' is amplitude mode (P, P-P, RMS). 'n' is the storage location and 'id' is the user's numeric text associated with the plot. <b>U(um:P-P,7,2012-07-08)&lt;CR&gt;</b>
Grrr,v.vv	This is the data line generated for each plot point. There are over 150 data points in a complete plot. 'rrr' is rpm and 'v.vv' is the associated vibration. <b>G1770,1.06&lt;CR&gt;</b> <b>G1778,1.21&lt;CR&gt;</b>
GE	This indicates the end of the plot data. <b>GE&lt;CR&gt;</b>

## Hardwire Interface

Interfacing the SB-2000 with a CNC or PLC machine controller is supported via a hardwire interface. The hardwire interface is provided via a standard DB-25 connector located on the rear panel. Because of the many possible variations and configurations of cabling required for such an interface, it is left to the operator to supply the necessary cable.

**When designing an interface for the SBS System, it is important to understand that the grinding machine's controller must operate the SBS System.** It is not possible for the SBS System to control the grinding machine.

Carefully read this entire manual before attempting to interface the SB-2000 with any machine controller.

### Hardwire Interface Overview

The hardwire interface consists of three sections: interface power supply, the inputs, and the outputs.

The interface power supply is provided exclusively for use with the hardwire interface inputs. It consists of three common pins and one output pin. The common pins are internally connected to chassis ground. The output provides a maximum of 30 mA at approximately +15VDC. Any external power used for interface I/O must be from a SELV (Safety Extra Low Voltage) source or supply.

The three inputs provide noise immunity and robustness. The inputs are activated by being pulled high, either by connection to the SB-2000 hardwire interface power supply output or by connection to a customer supplied signal. Activating the inputs requires at least 8 mA at a voltage between 10 and 26 volts, AC or +DC, referenced to the SB-2000 hardwire interface power supply common. The common pins are internally connected to chassis and earth ground. The inputs are deactivated by removing the connection to the power or signal source.

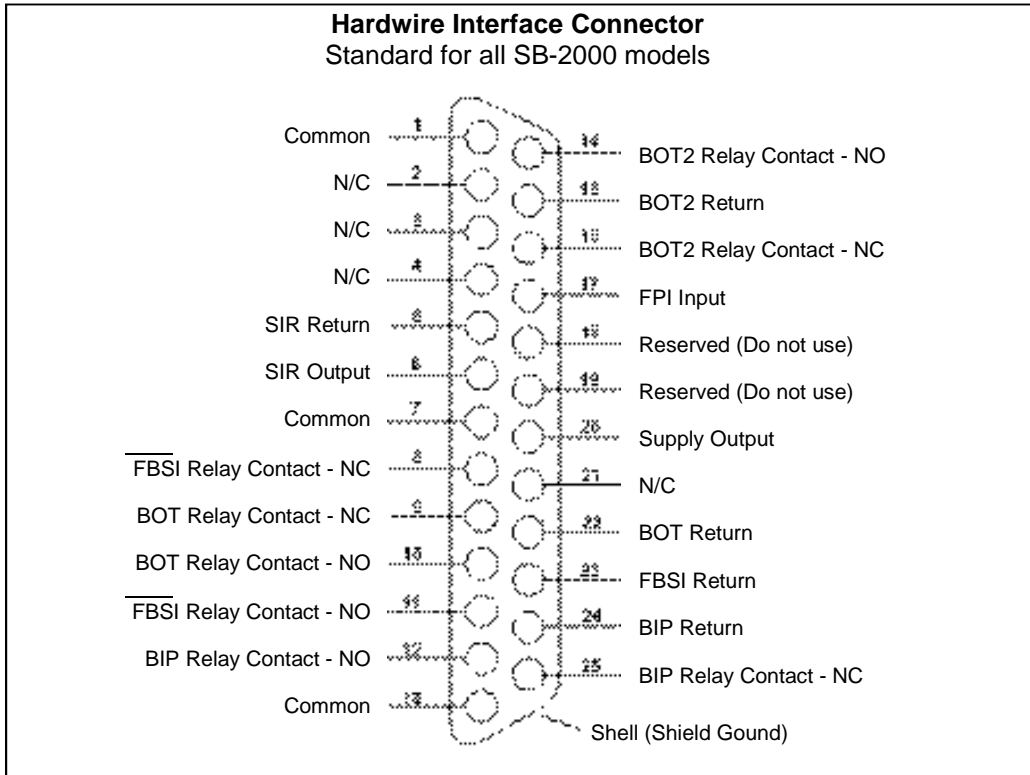

The four primary outputs consist of optically isolated, solid state, single-pole/double-throw relays. These relays may be used to supply an output signal by connection to a voltage source supplied by the customer. The relay contacts are electrically isolated from all other circuits and are rated for 24 Volts DC or AC, 50 mA maximum. Inductive loads must be protected against flyback to 50VDC.

The three contacts of a single-pole/double-throw relay are referred to as “normally open”, “normally closed” and “common”. The term “common” in this sense does not imply connection to power supply commons. The term “return” is used below to indicate the common contact of the relay.

Input Pin Names and Functions

Pin#	Name	Description
17	FPI	Front Panel Inhibit- When active, key operator actions at the front panel keypad are disallowed from the main screen. All ongoing activities are allowed to continue until the unit returns to the main screen, except setup. (🔒) The activation of the FPI input while in setup cancels the setup activity and returns to the main screen.
1	COMMON	Reference ground for input signals.
7	COMMON	Reference ground for input signals.
13	COMMON	Reference ground for input signals.
20	+15VDC	+15V DC Supply to be used only for input activation.

### Output Pin Names and Functions

<b>Pin#</b>	<b>Name</b>	<b>Description</b>
<b>22 10 9</b>	<b>BOT-R, BOT-NO BOT-NC</b>	Balance Out of Tolerance: Return, normally open, and normally closed contacts. This relay is energized when the sensed vibration level exceeds the operator defined Tolerance. Function of this relay during a balance cycle matches the SB-5500 'SB-2500' setting.
<b>15 14 16</b>	<b>BOT2-R BOT2-NO BOT2-NC</b>	Balance Out of Tolerance Two: Return, normally open, and normally closed contacts. This relay is energized when the sensed vibration level exceeds the operator defined Critical Tolerance, or when the spindle RPM exceeds the operator defined Critical RPM. Function of this relay during a balance cycle matches the SB-5500 'SB-2500' setting.
<b>24 12 25</b>	<b>BIP-R BIP-NO BIP-NC</b>	Balance In Progress: Return, Normally Open, and Normally Closed contacts. This relay is energized while a manual balance operation is in progress.
<b>23 11 8</b>	<b>/FBSI-R /FBSI-NO /FBSI-NC</b>	Failed Balance/ System Inoperative: Return, normally open, and normally closed contacts. This relay is energized after a successful Power On Self-Test or when the power is disconnected. It is de-energized if a fault condition arises.
<b>6 5</b>	<b>SIR SIR-R</b>	Spindle is Rotating. This relay closes to indicate the spindle is rotating. The user may set a minimum RPM value for this function. The SIR relay function cannot be disabled.

Pins 2, 3, 4, 18, 19, and 21 are not connected.

# CNC/System Timing Diagram

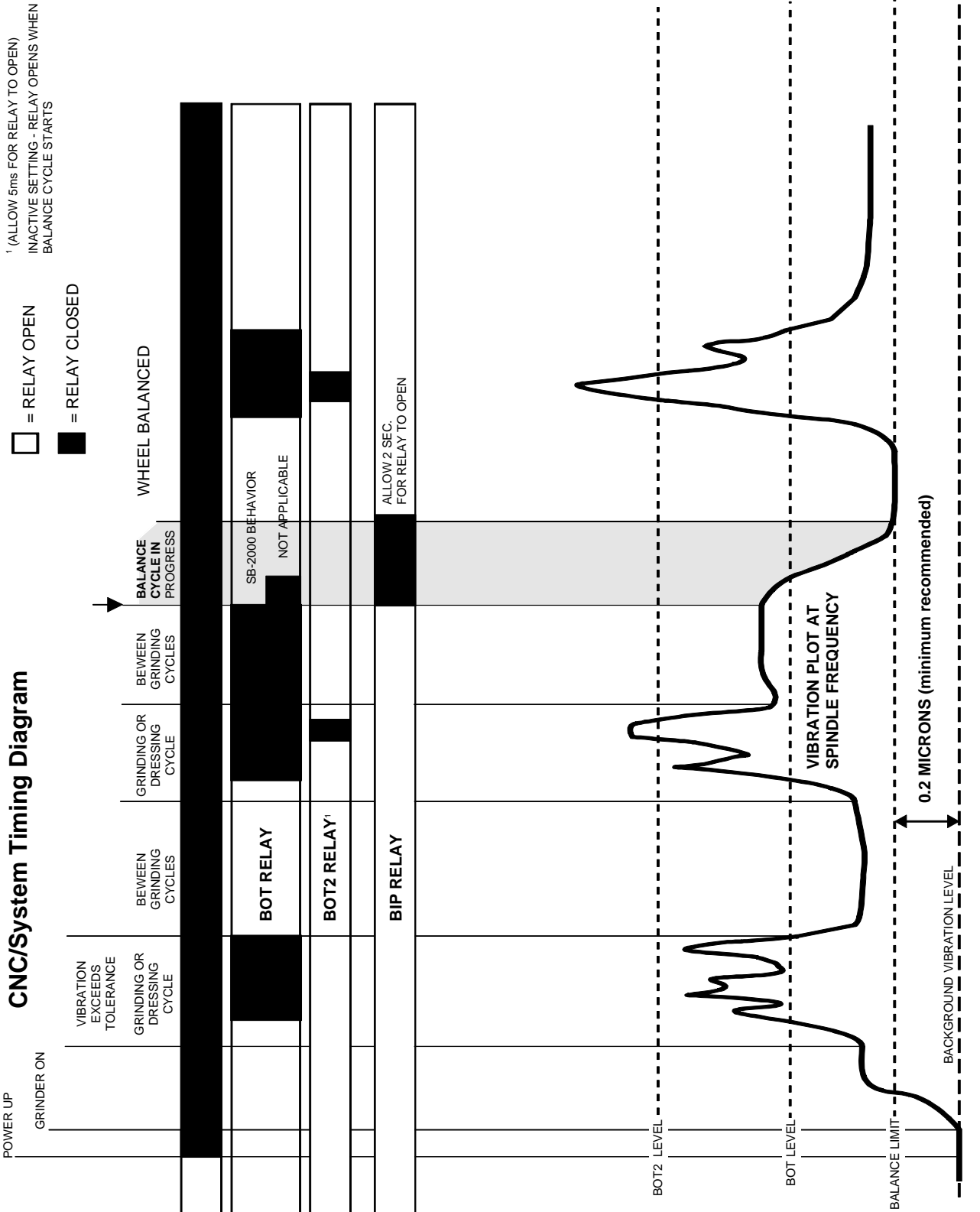

## System Maintenance

### RPM Sensor Cable (SB-18xx)

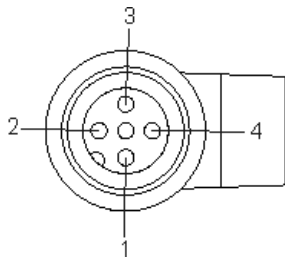

**RPM Sensor End**  
M12-4F Pin View

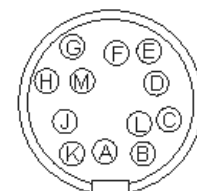
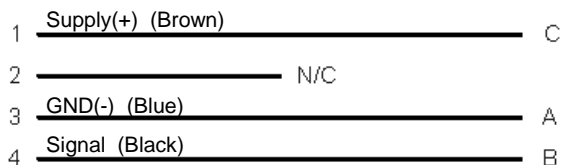

**Control End**  
Circular DIN-12M  
Pin View

### RPM Sensor Extension Cable (SB-19xx and SB-35xx)

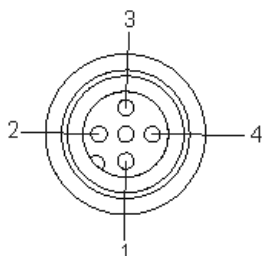

**RPM Sensor End**  
M12-4F Pin View

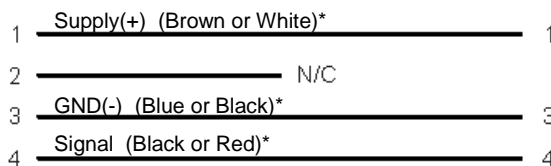

\* (2) versions of cable

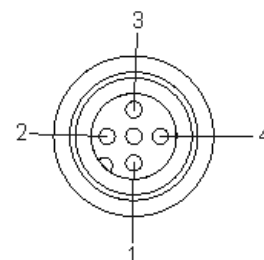

**Control End**  
M12-4M Pin View

### Vibration Sensor

**SB-34xx - Control End**  
M12-4F Female  
Pin View

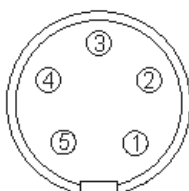

**SB-14xx - Control End**  
Circular DIN-5M  
Pin View

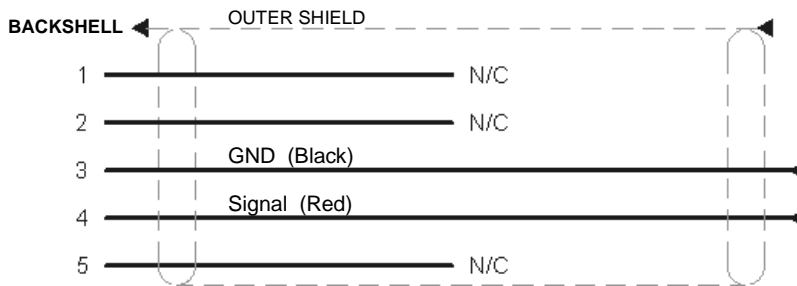
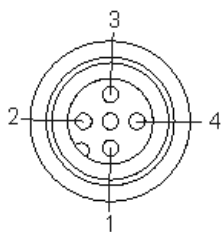

### SBS Return/Repair Policy

Schmitt Industries' policy is to give highest priority to the service needs of our customers. We recognize the cost of machine downtime, and strive to deliver same day repair of items arriving by overnight delivery at our facility. Because of the complication and delays involved with international shipments, customers outside the continental U.S. should contact their local SBS source for service support. Before returning any equipment for repair, it is necessary for you to contact Schmitt Industries, Inc. for a Return Materials Authorization (RMA) number. Without this tracking number, Schmitt Industries cannot ensure prompt and accurate completion of your repair needs. Failure to obtain an RMA number may result in substantial delay.

## Trouble Shooting Guide

This guide is designed to help you if you experience problems with your SBS Balance System.

**Step 1** ERROR MESSAGES. If the balance Control Unit is displaying any error messages, refer to the Error Indications section of this manual for explanation of the message(s) displayed. Contact Schmitt Industries for assistance as required. **If reporting a service issue, please indicate the Error Code (letter) of any displayed Errors.**



**Step 2** VIBRATION SENSOR. If no error messages are displayed, check the Vibration Sensor. Verify that the Sensor is firmly seated on the machine, its magnet firmly tightened in place, and it is properly connected to the Control Unit. Also check that the Sensor's position on the grinding machine accurately reflects machine balance (*see: Vibration Sensor Location section*).







As a final check, set the RPM manually on the Control Unit to the operating speed of the grinder, and verify that there is an incoming vibration signal. If you receive a near zero reading from the Sensor after manually setting the RPM, the Vibration Sensor and Control Unit should be returned for repair. Contact Schmitt Industries for a return materials authorization (RMA) number.

**Step 3** If the control unit's self-check shows no service problem with the SB-2000, then investigate environmental/application issues. The background vibration level on the machine should be monitored under operation, and the Balance Limit setting checked against this level. (*see: Environmental Considerations section*)

**If you continue to have problems after following these steps, contact Schmitt Industries, or your SBS Balance System source for assistance.**



### Factory defaults

Holding the  button down during power-up resets all configurations back to factory defaults. To confirm the default action, the display will show the  screen icon until the button is released. This action is not allowed if the FPI input is active on the CNC hardwire interface.

Defaults For System:	Defaults For Planes  ,  :	Defaults For Plot (Plot Setup):
Planes (  )	Limit (0.40)	All Plot locations Empty.
Vibration Units (µm)	Tolerance (1.20)	ID ("2012-07-18")
Amplitude (p-p)	Critical (20.00)	Sensor (  ,  if System Plane is  )
Critical RPM (OFF)	Balance Type (2 spread weights)	Vibration Units (Use System value)
Minimum RPM (OFF)	Circumference (200.0)	Amplitude (Use System value)
Manual RPM (500)	Circumference Units (cm)	Start RPM (1500)
	Fixed positions (4)	End RPM (6000)
	Scale Direction (Same)	Mode (  Continuous)
	Test Weight (0.1)	
	Weight Units (g)	
	Add/Total Mode (+)	



## Error Messages

The  screen icon is displayed when the error can be hidden manually by pressing the  button. The Error screen icon blinks for emphasis on these error screens.

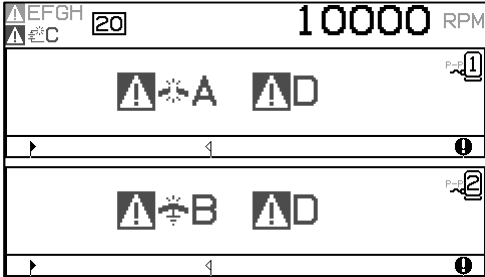
Error Code	Message	Description
<p>E, F, G, Z, Y, X, W, V</p>		<p>Checked on initialization. Each letter indicates a separate problem: Can proceed: E – Controller has older logic. Recommend factory update. F – Controller has PLL logic problem. Recommend factory repair. G – Missing Calibration. Recommend factory update. H – Checksum Error. Recommend flash update.</p> <p>Cannot clear. Generally not to be found in released units. System cannot operate. Z – Stack re-initialization not allowed. Try flash update. Y– Insufficient stack space. Try flash update. X – FPGA not recognized. Requires factory update. W –FPGA not compatible. Requires factory update or requires flash update with old code.</p>
<p>A, B, C, D, E, F, G</p>		<p>Checked continuously. Clears automatically. A – <b>Vibration</b> sensor is <b>open</b>, unplugged, or faulty. B – <b>Vibration</b> sensor is <b>shorted</b> or faulty. C – Low +15V to RPM sensor and CNC connector. Check sensor and/or cable for short circuit. Check CNC connections for short circuit. D – Unable to measure vibration. Control may need repair.</p> <p>Also from initialization: E – Controller has older logic. Recommend factory update. F – Controller has PLL logic problem. Recommend factory repair. G – Missing Calibration. Recommend factory update. H – Checksum Error. Recommend flash update.</p>

## Appendix A: Specifications

### Physical Features

#### Display

Type: Color TFT LCD  
 Active area: 480H x 272V pixel  
 3.74 inch [95mm] x 2.12 inch [53.86mm]

#### Communication Interfaces

CNC/PLC Hardwire Interface (opto-isolated outputs)  
 USB 2.0

**DC Supply:** Input 22 VDC to 26 VDC.

0.5A max at 22 VDC.

Reverse voltage protected.

#### Power Connector:

SB-2000: Phoenix 1803578 or equiv.

SB-2000-P: M12-8pin Female

### Environmental and Installation

Pollution degree 2  
 Installation category II  
 IP54, NEMA 12  
 Environmental temperature range: 5°C to +55°C

### Performance

#### RPM Reporting

30 to 100,000 RPM

#### Vibration Range

50 µg to 1.25g

#### Vibration Display Resolution

Four digit display, with display resolution to 0.0001 µm

#### Vibration Display Repeatability

6,000 RPM ±1% @ 5.0 µm  
 30 – 100,000 RPM ±2% @ 50:1 signal to noise

#### Vibration Display Accuracy

6,000 RPM ±2% @ 5.0 µm  
 30 – 100,000 RPM ±4% @ 50:1 signal to noise

#### Vibration Filter

Custom digital filter has bandwidth of  
 +/- 7% of measurement at 0-40,000 RPM  
 +/- 14% of measurement at 40,000+ RPM

#### Certifications

ETL and CE certified

[www.grindingcontrol.com/support/certifications/](http://www.grindingcontrol.com/support/certifications/)

## Appendix B: Replacement Part List

<b>SB-2000 (Dedicated Installation)</b>	<b>SB-2000-P (Portable Version)</b>
<b>RPM Sensors and Cables</b> SB-1800 RPM Proximity Sensor SB-1802 RPM Optical Sensor SB-18xx RPM Sensor Cable, DIN-12M - M12-4F SB-46xx Extension Cable, DIN-12M - DIN-12F CA-0173 Connector, DIN-12M (SB-18xx) CA-0121 Connector, DIN-12M (SB-46xx) CA-0122 Connector, DIN-12F (SB-46xx)	<b>RPM Sensors and Cables</b> SB-1800 RPM Proximity Sensor SB-1802* RPM Optical Sensor SB-1916* RPM Sensor Cable 5m/ 16ft, M12-M12 -90° SB-19xx RPM Sensor Cable, M12-M12 -90° SB-35xx Extension Cable (M12-M12 straight) CA-0236 Connector, M12-4F CA-0238 Connector, M12-4M
<b>Vibration Sensors</b> SB-14xx Vibration Sensor w/ cable SB-16xx Sensor Extension Cable, DIN-5M - DIN-5F CA-1112 Connector, DIN-5 M (SB-14xx, SB-16xx) CA-0113 Connector, DIN-5 F (SB-16xx)	<b>Vibration Sensors</b> SB-34xx* Vibration Sensor w/ cable SB-35xx Extension Cable (M12-M12 straight) CA-0236 Connector, M12-4F CA-0238 Connector, M12-4M
<b>Control Options</b> SK-5005 Keypad Mount: Flush Panel Frame Kit SB-24xx-L Hardwire Interface cable	<b>Miscellaneous</b> SB-1500* Carry Case with foam inserts SB-1799* RPM Sensor Stand (Magnetic Base) SB-1875* Power Supply w/ plug adapters MC-1502* SBS Cable Wrap MC-1716* Reflective Tape, 0.3m/ 1ft (for SB-1802) MC-1804 Mount Clip: RPM sensor (part of SB-1799)
<b>Miscellaneous</b> MC-1716 Reflective Tape, 0.3m/ 1ft (for SB-1802)	

xx in P/N = cable length in feet, e.g. SB-4611 = 11ft [3.5m]

\* Portable Balancer kit item (SB-2020 kit includes 1 SB-3420 Vibration sensor, SB-2040 includes 2)

# Appendix C: System Connection Diagram

