

SBS AEMS System User's Guide

with SB-5500 Series Controls

LL-5200, Rev. 1.6

Productivity through Precision™

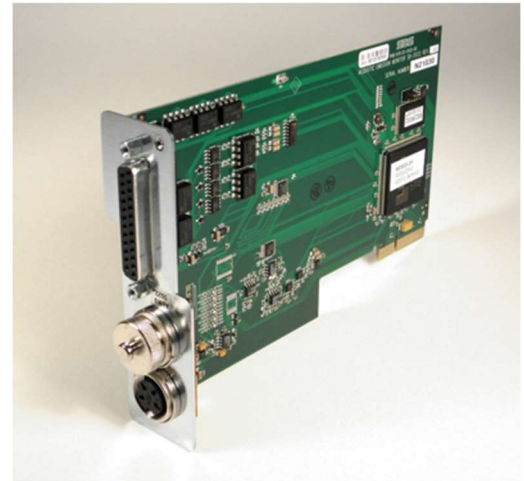



Limited Use License Agreement

CAREFULLY READ THE FOLLOWING TERMS AND CONDITIONS BEFORE OPENING THE PACKAGE CONTAINING THE PRODUCT AND THE COMPUTER SOFTWARE LICENSED HEREUNDER. CONNECTING POWER TO THE MICROPROCESSOR CONTROL UNIT INDICATES YOUR ACCEPTANCE OF THESE TERMS AND CONDITIONS. IF YOU DO NOT AGREE WITH THE TERMS AND CONDITIONS, PROMPTLY RETURN THE UNIT WITH POWER SEAL INTACT TO THE DEALER FROM WHOM YOU PURCHASED THE PRODUCT WITHIN FIFTEEN DAYS FROM DATE OF PURCHASE AND YOUR PURCHASE PRICE WILL BE REFUNDED BY THE DEALER. IF THE DEALER FAILS TO REFUND YOUR PURCHASE PRICE, CONTACT ACCRETECH SBS, INC. IMMEDIATELY AT THE ADDRESS FOLLOWING CONCERNING RETURN ARRANGEMENTS.

Accretech SBS, Inc. provides the hardware and computer software program contained in the microprocessor control unit. Accretech SBS, Inc. has a valuable proprietary interest in such software and related documentation ("Software") and licenses the use of the Software to you pursuant to the following terms and conditions. You assume responsibility for the selection of the product suited to achieve your intended results, and for the installation, use and results obtained.

License Terms and Conditions

- a. You are granted a non-exclusive, perpetual license to use the Software solely on and in conjunction with the product. You agree that the Software title always remains with Accretech SBS, Inc.
- b. You and your employees and agents agree to protect the confidentiality of the Software. You may not distribute, disclose, or otherwise make the Software available to any third party, except for a transferee who agrees to be bound by these license terms and conditions. In the event of termination or expiration of this license for any reason whatsoever, the obligation of confidentiality shall survive.
- c. You may not disassemble, decode, translate, copy, reproduce, or modify the Software, except only that a copy may be made for archival or back-up purposes as necessary for use with the product.
- d. You agree to maintain all proprietary notices and marks on the Software.
- e. You may transfer this license if also transferring the product, provided the transferee agrees to comply with all terms and conditions of this license. Upon such transfer, your license will terminate and you agree to destroy all copies of the Software in your possession.

User's Guide and Specification

For the

SBS AEMS System

Covering Operation of SB-5522, SB-5522-6, and SB-5519

with Model 5500 series Control Units

LL- 5200

Manual Revision # 1.6

Covers operation with product firmware rev. 0.41

© 2020 Accretech SBS, Inc.

Corporate Offices

2451 NW 28th Avenue
Portland, OR 97210 USA

sales@accretechSBS.com

Tel: +1 503.595.4270

Fax: +1 503.595.4271

<https://accretechsbs.com/>

Benefits of SBS AEMS System with SB-5500 Control:

- Increases throughput by saving setup time
- Improves part quality by providing grind and dress quality monitoring
- Gap Elimination - Increases throughput by reducing unproductive grind infeed.
- Crash Protection - Quick detection of extreme wheel contact to allow feed shutdown and prevent dangerous wheel crashes.
- Four-channel capability reduces costs by permitting both balancing and AEMS monitoring of multiple machines
- Longer life for grinding wheels, dressing wheels and spindle bearing
- Enhanced digital electronic design with increased operating life and reliability
- Easy to install and operate
- Works with existing SBS installations
- Profibus, Ethernet and USB 2.0 communication
- International adaptability: voltage, frequency, communication, and display language
- Backed by world-class SBS customer service

Table of Contents

<u>General Instructions</u>	1
System Purpose.....	1
Operator Safety Summary	1
System Theory and Connection	2
Control Unit Overview	3
IVIS Software Interface.....	3
Front panel controls	3
Power-on display	4
SETUP	4
Control unit without front panel connected	4
System Installation.....	5
System Connections.....	5
AEMS card rear panel connections	5
SB5580	6
Firmware Update and Save or Recall of System Settings	6
Acoustic Sensor Location	7
AE Sensor Types	7
SB-5522-6 model.....	8
SB-5519 model.....	8
Control Unit Instructions.....	9
Explanation of M1 and M2	9
Main Screen Operation.....	9
SETUP	10
MENU screen	10
CNC Signal Time	10
CNC Crash Latch	11
CNC Function – Stop/Start	11
Channel Name	11
Menu Entry.....	11
Job Configuration	12
Factory Settings	12
Job# (Job No.) - Multiple Parameter Sets.....	12
Limit Screen	13
Limit Edit	13
 Screen	14
<u>AEMS Operation</u>	15
M1 and M2 Parameter Menu.....	15
Learn Cycle.....	15
Learn AIR.....	15
Frequency bands defined	16
Frequency Band Selection and Short Work Cycles.....	16
Set Frequency Band 8	16
SB-5522-6 Sensor Selection.....	16
Learn WORK	17
Learn Data screen	17
Verify Normal Operation.....	17
Graph Time.....	18
Graph Type.....	18
Peak Detect	18
Frequency Band	18
Plot Scale.....	18
Hardwire Interface.....	19
Hardwire Control Interface – AEMS Card.....	19
Input Pin Names and Functions	20
Output Pin Names and Functions.....	20

AE Signal Analog Output	21
Profibus DP Interface	22
Software (USB or Ethernet) Interface	22
Interfacing	22
Software Commands and Responses	22
Displayed Error Messages	24
Support.....	25
Appendix A: Specifications	26
Appendix B: Replacement Parts List	27
Appendix C: AEMS Card Installation	28
Appendix D: AEMS System Connection Diagram	29

General Instructions

System Purpose

The SBS AEMS System has been developed to provide process control enhancement to grinding machine operators. “Gap” elimination, Crash Monitoring, and Monitoring of wheel contact in the Grinding and Dressing processes are all provided, with the following objectives in mind:

- **Ease and Usefulness of Operation**
- **Maximum Grinding Machine Efficiency**
- **Minimal Installation Requirements**
- **Close Integration with SBS Balance Systems**
- **Attractive Purchase Price**

Operator Safety Summary

This summary contains safety information necessary for operation of the SBS Balance System for grinding machines. Specific warnings and cautions are found throughout the Operation Manual where they apply, but may not appear in this summary. Before installing and operating the SBS Balance System, it is necessary to read and understand the entirety of this manual. After reading the Operation Manual, contact Accretech SBS, Inc. for any additional technical assistance required.

- Warning:** Observe all safety precautions for operation of your grinding machinery. Do not operate your equipment beyond safe balance limits.
- Warning:** Failure to properly attach SBS Balance System or AEMS sensor components to the grinding machine spindle, including the proper use of provided adaptor lock screws, will result in safety hazard during machine operation.
- Warning:** Never operate a grinding machine without all proper safety guarding in place.
- Caution:** To avoid equipment damage, make sure the line voltage is within the range specified for the system (see specification section).
- Caution:** Only qualified service technicians should attempt to service the SBS System. To avoid electric shock, do not remove the cover of the Control Unit, or remove cables, with power connected.

System Theory and Connection

The AEMS system consists of an electronic control and either one or two acoustic emission (AE) sensors. This electronic control is packaged as a separate device card to be inserted in SB-5500 series Control units. The AE sensors are mounted on the grinding machine and located to detect high frequency acoustic emissions generated in the machine structure resulting from wheel contact in either the grinding or dressing process. The level of these signals are monitored and referenced against known background levels at the same frequency, allowing key events to be automatically and quickly detected on the grinding machine as they occur. These events include: Initial contact of the grinding wheel to the dresser or work-piece (gap control), abnormal or severe contact between the wheel and these parts (crash protection), or assurance of either a maximum or minimum degree of wheel contact throughout the dress or grind cycle (process monitoring). These events are then reported via both the hardwire and software interfaces, and the Control's front panel display. Machine CNC controls can be programmed to use this information to eliminate Gap dwell time, protect against damage resulting from part crash, and monitor the quality of the grinding and dressing process.

Control Unit Overview

The following is an overview of the control and interface features of the SBS SB-5500 Control Unit.

IVIS Software Interface

The standard unit is delivered with an LCD display panel and keypad. This manual describes the hardware panel user interface for this product. IVIS Software from SBS can also be used as the user interface on some machine CNC systems. All the basic concepts, data presentation, and parameter settings described are also presented in the IVIS interface but organized visually with some differences. Read the IVIS Operations manual in conjunction with this product manual when using the IVIS user interface.

Front panel controls

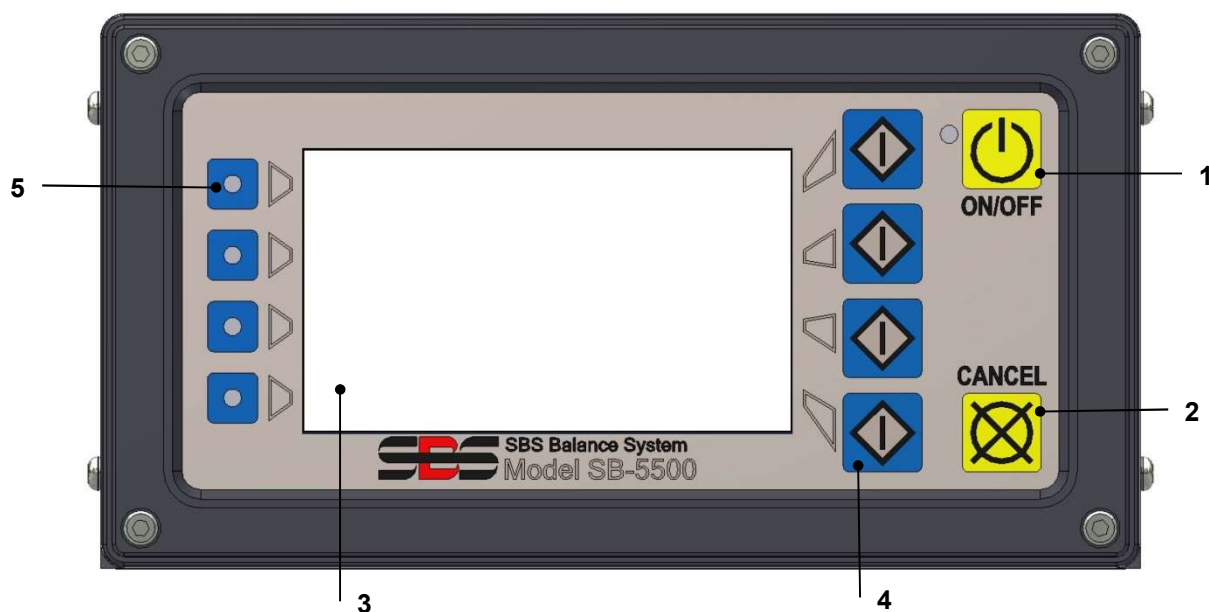

The Figure above illustrates the controls and indicators on the front panel of the Balance Control Unit. The following is a description of these features:

- 1) **ON/OFF.** This button turns on the operating power for the system. When the system is turned on the unit initiates a Power-On Display, and the green LED to the left of the button will be illuminated. When turned OFF the unit is in the stand-by mode, and the green LED is blinking. This indicates power is connected to the unit, but the control is inactive.
- 2) **CANCEL BUTTON.** Pressing this button will cancel the operation in progress, or the last selection or entry made. Also clears any displayed error message.
- 3) **LCD DISPLAY.** **The display is not a touch screen. Do not press on the display screen.** The screen is used to display data and assign functions to the function buttons.
- 4) **FUNCTION BUTTONS.** Operation of the Control unit is accomplished via the four function buttons to the right of the display. The menu bar area of the display, to the left of these buttons, assigns the current function to each button. Use these buttons to make all operational selections.
- 5) **SLOT STATUS LED.** A three-color LED on the left side of the display shows the operational status of the balancer card or other device cards installed in each of the four corresponding card slots.

Power-on display

The Front Panel of the control can be removed and remotely mounted using a SB-43xx series cable. When switched on in either configuration the Control Unit performs self-analysis which defines its status, and the setting of operating parameters. Operator information is then shown on the LCD display following the startup sequence described below:

- 1) The company logo screen is displayed and lights on the front panel are illuminated to verify their operation. During this short time, the SETUP button is available. Pressing this button will enter setup mode for the control.
- 2) After four seconds, the unit displays information about each balancer or device card installed, indicating type of device and identifying information. To extend the time that this information is displayed, press any one of the function buttons while the slot information is on the screen. Each button press will add six seconds to the display time, giving additional time to read the information.
- 3) After two more seconds, the unit displays the initial operational screen for the control unit. The unit will display either the SHOW ALL monitor screen, or one card slot's main operating screen, whichever was selected when the unit was last switched off.
- 4) Any error conditions detected by the self-analysis are displayed as "ERROR - *code*" where *code* lists the reference code of the error detected. For detailed description of error codes, see the "Displayed Error Messages" section of this manual, or additional product instruction addendum manuals.

SETUP

At Power-on, press the SETUP button to enter this mode. The Setup screens allow the user to select:

1. Operational language
2. Ethernet settings
3. Profibus Station ID (if installed)

While in Setup mode:

- Press ENTER to save current settings on the screen and/or proceed to the next Setup screen
- Press CANCEL to cancel unsaved settings on the screen and/or proceed to the next screen
- Press START to cancel unsaved settings, exit Setup mode, and start operation.

CHOOSE SYSTEM LANGUAGE SETTING	▲	ETHERNET SETTINGS	▲	PROFIBUS SETTING	▲
ENGLISH	▼	MAC:00-23-BB-00-0A-03	▼	STATION ADDRESS: 3	▼
DEUTSCH		IP: 0. 0. 0. 0		REPORT ERRORS: YES	
ESPAÑOL		SNET: 0. 0. 0. 0	▶	NETWRK SCAN GSD: 5	
FRANÇAIS	START	GW: 0. 0. 0. 0			START
ITALIANO		DHCP:ENABLED			
РУССКИЙ	ENTER		ENTER		ENTER
SVENSKA					

The first Setup screen selects the language used by the control. Use the arrow buttons to scroll through the available languages. The second Setup screen allows Ethernet settings. Manual settings can be made or DHCP can be enabled for automatic assignment. Use the arrow buttons to scroll through all the available Ethernet settings and use the up and down arrows to change digits.

If Profibus is installed, the third screen allows selection of Station ID and other items. For more information see the Profibus manual available at <https://accretechsbs.com/>.

Control unit without front panel connected

The control unit can be operated without a user interface attached, providing the monitoring functions via the CNC, Profibus, and Software Interface. The user interface is only required for setting all parameters.

System Installation

System Connections

The back panel of the SB-5522 AEMS card is shown installed in slot 1 (S1) of the SB-5500 control below. The device can be identified by the two 4-pin circular DIN connectors, for connecting the acoustic sensors, and a female DB-25 for Digital I/O connections. The first sensor position at 9a is SENSOR 1 (-①) and can be used to monitor both M1 and M2 (described in following section). The second sensor connector at 9b is SENSOR 2 (-②) and can only be used to monitor M2. In cases where only one sensor is to be used, connect to SENSOR 1.

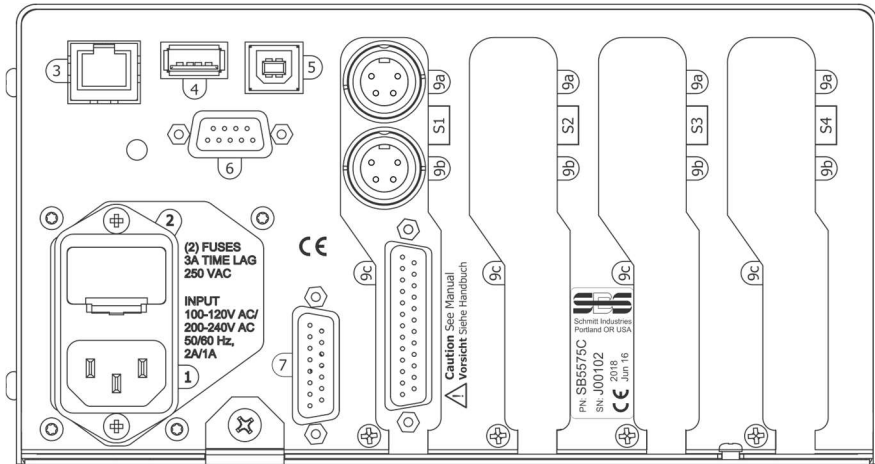

- 1) POWER SUPPLY. Connection for line power input (AC input model shown)
Caution: Before applying power to the Control, make sure the supply voltage is within specified range.
AC Input Models: 100-120V AC, 200-240V AC, 50-60 Hz
DC Input Models: 21 VDC to 28 VDC. 5.5A max at 21 VDC.
 - 2) FUSE HOLDER. Contains the line fuses. AC Input Controls use (2) 5x20 3A time lag, DC Input Controls use (1) 5x20 6.3A.
 - 3) ETHERNET. Provides TCP/IP and UDP Connection to host device, such as CNC Controller or IVIS.
 - 4) USB CONTROLLER. Allows USB flash drive to be connected for Firmware update.
 - 5) USB DEVICE. Provides connection to another USB 2.0 host, such as a CNC Control.
 - 6) PROFIBUS. Provides connection to Profibus DP host device, such as CNC Control (option).
 - 7) REMOTE. This DB-15 connector receptacle is a duplicate of the connector on the front side of the box, used to connect the optional cable for remote front panel installation.
- S1-S4 DEVICE SLOTS. Numbered Slots are available for installation of device cards supplied by SBS. Unused Slots are covered with blank panels.

AEMS card rear panel connections

The control comes standard with one card, and others can be purchased and added to the control unit as required. Each card has three connections on the rear panel of the control.

- 9a) AEMS SENSOR CONNECTION. Connects to an AEMS Sensor.
- 9b) AEMS SENSOR CONNECTION. Connects to a 2nd AEMS Sensor (optional).
- 9c) HARDWIRE INTERFACE. Standard DB-25 connector for connecting the individual AEMS card in the control to a grinding machine controller. A complete description of this interface is given in the “Hardwire Interface” section.

SB5580

The SB-5580 is a smaller chassis version of the SB-5500 control series, which has been designed for the space constraints of mounting inside the electrical cabinet of the grinding machine. It supports four device cards of the same series (S1-S4), and requires power input of 24 VDC, with the same specification as SB-5500. The panel connectors are the same and are labeled in the same way as SB-5500 above, except for the USB DEVICE connector which is located on the bottom of the control instead of the back panel.

A 3-slot version is available and both sizes are also available in a Profinet configuration. For the Profinet, connection 3 is maintained for the standard Ethernet communications and connection 6 is changed to an Ethernet connector for the Profinet communication. See the Profibus manual.

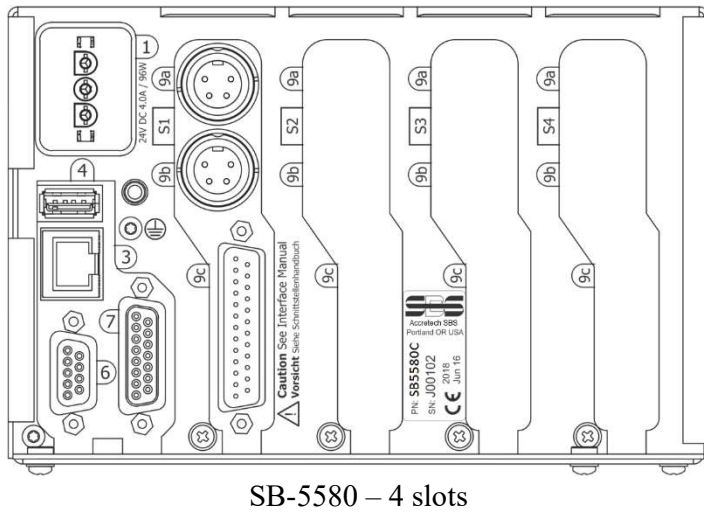

SB-5580 – 4 slots

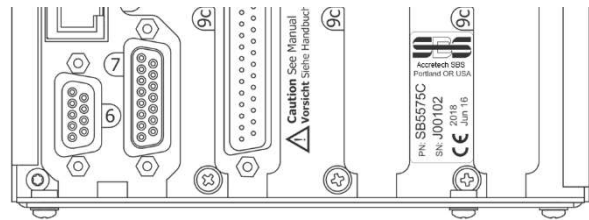

SB-5575 – 3 slot version

Profinet configurations:

SB-5576 – 3 slots

SB-5581 – 4 slots

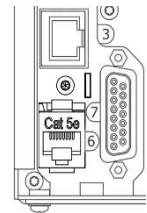

Firmware Update and Save or Recall of System Settings

Insert a USB flash drive into the USB CONTROLLER connection on the rear panel. You will be presented with an English language menu with icons as described following. If this menu does not display, ensure that the control is not in a menu screen, then re-insert the USB drive.

Save Settings  allows user settings for each installed device card in the SB-5500 control to be saved to individual files on the USB drive. Settings can be backed up for future reference, or to be copied from one control to another. When this button is pressed, a folder named SAVE is created on the root of the USB drive, and files are saved at that location for each device card in the control. Any existing files for the same device card type(s) in the SAVE folder will be overwritten.

Recall Settings  allows the saved files to be used to update settings on the same or another connected control. This process will overwrite all existing settings on the connected control unit and instead make the saved settings active. A folder named RECALL must be created by the user at the root of the USB drive. Device card files must be copied to that location using a separate PC when the user wants to use them in the recall process. When this button is pressed, any files located in the RECALL folder will be written to the control unit. SBS recommends erasing the RECALL folder after use to ensure files are not later accidentally used.

Firmware Update . The latest firmware for the control unit and all associated device cards is available in a zip file downloadable from the SBS website: <https://accretechsbs.com/>. Included in the zip file is a detailed readme file in English which describes the firmware versions included and covers the update process. **Important** - It is important that all installed device cards, the control display PCB (5547Rxxx.sbs) and the

main PCB (5510Rxxx.sbs) are all updated to the latest firmware version included in the zip file to ensure full functionality.

Acoustic Sensor Location

Choose an appropriate sensor location on the grinder for testing. The Sensor must be mounted to the machine casting or some other rigid machine structure. Do not mount acoustic sensors on thin or loosely attached machine components such as wheel guards. The mounting spot should be reasonable flat, and must be free of foreign matter such as swarf. Paint removal is advisable but not required.

The critical issue to be considered in placing the sensor is acoustic transmission quality. The sensor should be location on a rigid part of the grinder so that the high frequency noise resulting from contact between the wheel and work part, or between the wheel and dresser unit, will travel to the sensor with minimal loss of signal. Signal loss will occur both with distance traveled through the machine structure, and especially with each part to part mating junction in the machine. What is desired is a short path of travel for the acoustic signal, through as few parts of the machine as possible, with all parts of this travel path being rigid, solid, and closely coupled and firmly mated portions of the machine structure.

For a Bolt-on sensor, it is recommended to use superglue (Loctite 401 or equiv.) to try some different mounting locations, until the best location is found.

It may be possible to mount one AEMS sensor on the spindle housing, near where the balancer sensor would be located, and use this location for monitoring both Dressing and Grinding. If this does not work on a particular machine structure, the alternative is to mount one sensor on the dresser structure for dressing monitoring, and another sensor on the tailstock, or other rigid portion of the part holding structure of the machine, for grinding monitoring. Two sensors can be connected, but only one is in use at any time by the AEMS system.

AE Sensor Types

A variety of Sensor configurations are available to fit your installation requirements. The Main types of sensors are pictured below. Each sensor type is available in various models and the user should consult the SBS Product catalog for details on all available models.



Bolt-On Sensor – The sensor is attached by a screw directly to the machine structure, nearest as possible to the contact point between the grinding wheel and the work piece or the wheel dresser.

Non-Contact Sensor – The sensor comes in two parts to allow mounting directly to the rotating work spindle or dresser spindle. A rotating part is mounted to the spindle to pick up the AE signal from wheel contact. A non-rotating part is mounted directly opposite the rotating part, where the AE signal is detected and transferred to the AE monitor.

Fluid sensor – The sensor allows detection of AE signal direct from the work piece or the wheel. A fluid stream (usually the filtered and pressure regulated machine coolant) is directed to flow onto the target area. The AE signal transmitted up the fluid stream and is detected by the sensor.

Balancer mounted Sensor – The sensor is integrated into Non-Contact mechanical external or internal SBS balancers.

SB-5522-6 model

This is a higher capability model variation of AEMS card. All operations are common to the SB-5522 as described in this manual, with the exception that instead of a maximum of two AE sensor connections being supported, up to six sensors can be connected and used. Related key functional changes for this model are listed in the manual where relevant.

SB-4100 optional cable adapter “Y” can be used to connect two AE sensors to each one of the SB-5522-6 card input connectors. Using two SB-4100 therefore allows 4 sensors to be attached to the SB-5522-6. The SB-4100 has two legs labeled A and B to which AE sensors are connected. The single connector end of SB-4100 must be directly installed to the SB-5522-6 AE input.

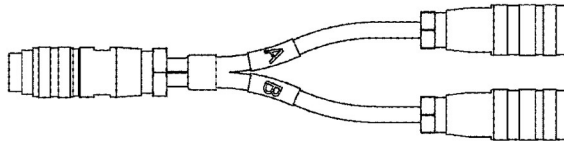

SB-4100
See drawing for more details

The SB-5522-E optional slot extension connector panel (not shown) can be used to add 2 additional sensor inputs (for a total of 6). This expansion panel takes up one slot in the control unit, and it must be installed in the control unit slot which is one position number lower relative to the slot where the SB5522-6 card is installed, e.g SB-5522-6 in **S2** and SB5522-E in **S1**. Using this connector panel allows up to 6 total sensor connections.

Sensor 1 -①	9a on SB-5522-6 direct	A-leg of SB-4100
Sensor 2 -②	9b on SB-5522-6 direct	A-leg of SB-4100
Sensor 3 -③	B-leg of SB-4100 via 9a on SB-5522-6	
Sensor 4 -④	B-leg of SB-4100 via 9b on SB-5522-6	
Sensor 5 -⑤	9a on SB-5522-E direct	
Sensor 6 -⑥	9b on SB-5522-E direct	

SB-4100 and SB-5522-E only function with SB-5522-6, not with standard SB-5522 card.

SB-5519 model

1. This is the SBS AEMs Basic product. All operations are the same as described in this manual, with the following limitations and exceptions:
2. This model has no hardware front panel interface and can only be operated via IVIS interface software. A message is displayed on the control panel “User Interface via IVIS Software Only”.
3. Only 2 sensor inputs are supported, designated by M1 and M2.
4. Provides only one evaluation (Limit G), with no other limits available.
5. Does not support multiple Jobs, so only provides 2 saved configurations (M1 and M2). Save/Recall does function for this one set of saved configurations.

6. Does not support user configuration of AE frequency band 8, only fixed bands 1 thru 8 are available for setup.
7. Only (1) SB-5519 can be supported in any SB-55xx series control unit. Adding a second card of this type will disable both cards.

Control Unit Instructions

Explanation of M1 and M2

Separate monitoring parameter sets (M1 and M2) are provided for monitoring the results of distinct processes on the grinder. The number of available parameter sets can be extended by use of the JOB# Menu setting which allows up to 16 different JOBS to be created, each with its own assigned M1 and M2 parameter set. A total of up to 32 distinct work processes can therefore be learned and monitored by the system. **SB-5522-6 note:** This product has a user settable menu option (32 JOBS) to disable the M1/M2 function and instead treat each saved configuration as a separate job (1-32). A work process is distinct if there is any variation in the contributing factors that would influence the AE signal intensity generated from wheel contact. This would include a change in any of the following: AE sensor location, grinding wheel size or type, dressing unit, work piece, feed rates, wheel RPM, and coolant type or flow. Setup parameters are all stored separately for each parameter set. M1 will always be associated with sensor 1 (Ⓛ), and M2 will be associated with sensor 2 (Ⓜ) if connected, or with sensor 1 when only one sensor is installed.

Main Screen Operation

Go to the SHOW ALL menu for the control unit, by pressing the SHOW ALL button from any card main screen. Select the AEMS card to be displayed.

This is the main screen of the AEMS system. A scrolling graph of the AE signal is displayed, with the current AE signal level shown as a numerical value at bottom left. The current Graph Time (number of seconds of data represented by the AE graph) is shown at bottom right. The Gap limit shown in green, limit 1 and limit 2 shown in blue, and the Crash limit shown in red are all adjusted using the SETUPLIMIT menu. Each limit is labeled at the right of the graph with a corresponding Limit label (G, 1, 2, C). These limits can be adjusted to any position and in any order on screen.

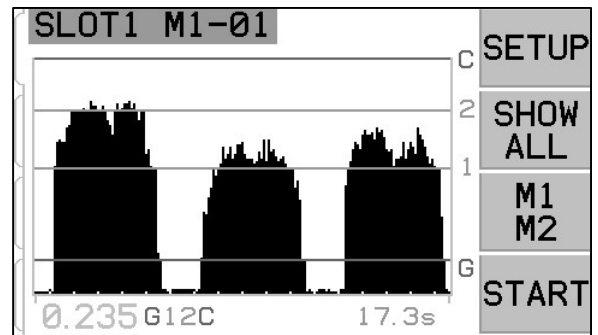

The screen can be formatted to show signal and the limits on either a Log (logarithm) or a Linear vertical scale. The default setting is Log scale. See Screen Scaling on the M1 or M2 Parameters Menu

When the current AE signal exceeds any of these set limits, the corresponding indicator symbol (G 1 2 C) is momentarily displayed to the right of the current AE signal level at bottom left of the screen. The bottom of the graph is set during Learn to a signal value equal to 80% of the learned Air value (see Sensor Learn Process). With no Learn process, then zero signal is set as the bottom of screen scale.

The Crash limit initially is set at the top of the screen scale after a Learn cycle. The top of the screen scale will be set just below the usable hardware range of the amplifier. It is possible to adjust any limit higher than the top of screen by using screen Zoom and Pan settings, or by adjusting the system Gain setting. When any Limit has been adjusted off screen (higher than top of screen) then a "+" sign is displayed above the highest Limit label (G, 1, 2, C) at the upper right of the graph.

Increasing the Gain setting can raise a Limit setting beyond the functional range of the hardware, and will result in the signal amplification hardware being maxed. This Error condition is indicated on screen by the indicator symbols (G 1 2 C) next to the signal value at bottom right being replaced by ****. In this condition, Error D – Limit Relay error will be displayed whenever the user switches to this main screen from a menu screen.

The SHOW ALL button simply returns the user to the system-wide menu screen, for monitoring all card channels installed in the SBS control unit, or to select another channel for detailed interface.

M1/M2 button toggles view and operation between these two modes. **SB-5522-6 note:** When the 32 JOBS configuration is selected, this button is disabled and not displayed. The two separate monitoring modes “M1”, and “M2” are identified with a corresponding screen label in the blue identification bar at the top of the screen. The currently selected mode is always shown in the upper screen label, along with the current channel name assigned to the AEMS card.

The START/STOP toggle button on the bottom right of the screen starts and stops the display from scrolling real-time acoustical signal levels currently being monitored. It is possible to stop or freeze the display, so that target levels can be adjusted against recent signal levels or for review of an event by the operator. Even when the screen is not scrolling, the unit will continue to monitor for gap and crash events, and provide their status via the CNC Connector.

SETUP

Pressing the SETUP button from the main screen allows the operator to access:

MENU screen – Revisable parameters for operation of the System

LIMIT screen – On-screen repositioning and editing of the Limit levels, shown relative to the current AE signal.

 Screen – Provides for manual adjustment of certain parameters normally set during the Learn process.

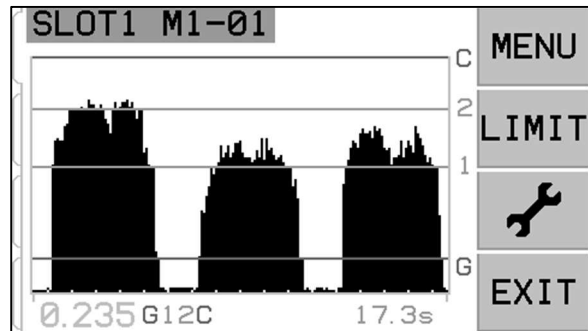

MENU screen

The Menu contains the user selectable operation settings for the AEMS system. Most parameters are stored independently for the two separate monitoring modes M1 and M2 and for each Job. These parameters are accessed under the M1 PARAMETERS and M2 PARAMETERS menu. **SB-5522-6 note:** When the 32 JOBS configuration is selected, this menu option is renamed “Parameters” These parameters are discussed in detail under the following AEMS Operation section of this manual.

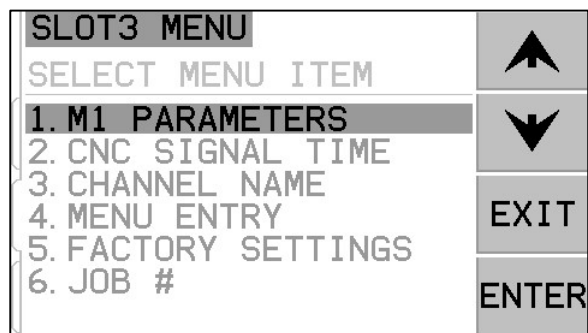

The other following menu items listed are general settings or functions for the general operation of the AEMS card, and are not specific to a certain M1 or M2 selection. If Job# selection is enabled (not set to OFF), then the Job# menu item will move to the first position in the menu list, to better facilitate switching between Jobs.

CNC Signal Time

Sets the minimum hold time, in milliseconds (msec.), that output contacts are opened or closed to indicate an event signal. **Important – The purpose is to make an event's signal last long enough to assure signal detection by the machine control used.** The factory default settings are 1 msec, but PLCs or similar devices

often will monitor at timed intervals of about 5 msec. In such cases the signal time must be set to exceed the polling cycle time. Affects Gap, LIM1, LIM2, and (if not latched) Crash signals of the CNC interface.

To change settings, select SETUP from the Main screen. From the Setup screen, select MENU with the corresponding button, then select CNC SIGNAL TIME from the menu. The two screens that follow control the ON and OFF contact hold times. Times can be set from 1 to 999 msec.

To set the desired time for the N.O. contact closed time, use the left arrow button to select digits, and the up and down arrow buttons to change the selected digit. Press ENTER to accept the entry and proceed to the OFF-TIME screen. In the same manner, set the time that the N.C. contact will be closed and press ENTER to save selection and advance to next option.

CNC Crash Latch

- OFF** Crash not latched, subject to ON/OFF times like Gap, LIM1, LIM2.
- ON** Crash condition closes the Crash N.O. contact until it is reset by: (1) RESET CNC input (2) HOST error clear (3) CLEAR button when Crash error screen is displayed.

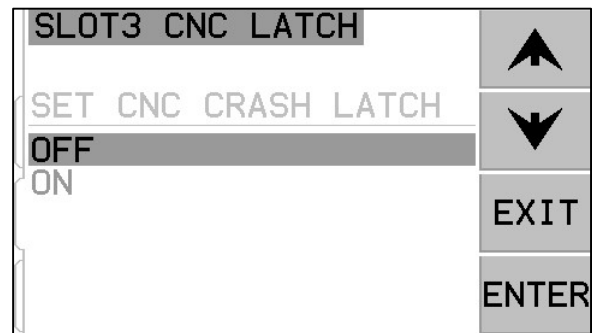

This menu option under CNC Signal Time sets how the Crash output signals will react to crash conditions. Use the up and down arrow buttons to toggle the cursor between the OFF or ON selections. Press ENTER to save selection and advance to next option.

CNC Function – Stop/Start

Menu option under CNC Signal Time activates or deactivates CNC control of the screen STOP and START functions. This function is always controllable via the front panel screen and menu buttons (MENU) and by the host port. When this option is set to MENU+HOST+CNC, the function of two inputs on the CNC port is modified to allow control of screen STOP and START. The inputs used for this control are the M1 and M2 inputs (see CNC input section for details). Press ENTER to save selection.

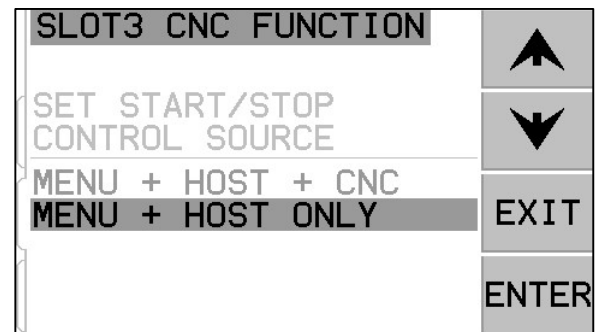

Channel Name

Selecting the CHANNEL NAME menu item will display an entry screen. Use the right arrow button to select cursor position, and the up and down arrow buttons to toggle through the alphanumeric list to label the AEMS card device. Custom labels can be used to identify each card device installed in the SBS control unit with this feature. Up to Five characters can be used to label the AEMS card. Press ENTER to save selection

Menu Entry

This selection on the menu list provides for use of a standard access code for menu protection. Setting the channel to the protected mode denies access to the menu list unless the access code is entered. This setting ensures that system settings will not be accidentally compromised. The screen displays ENABLED when Menu access is available, and PROTECTED when menu access is controlled by the access code. Function buttons are assigned the numbers 1, 2, 3, and ENTER, which are used to input the access code. The standard access code is **232123**. Once the code has been entered and the ENTER button has been pressed the MENU selection is protected. Re-entry to the menu list will now require entry of this code. The message MENU ACCESS PROTECTED will be displayed notifying the user that the menu is password protected, and the user will be

given the opportunity to enter the code. Entering a code other than the correct number will produce a message
INCORRECT CODE ENTERED TRY AGAIN/ CANCEL.

To disable menu protection, enter the correct code to access the menu, select the MENU ENTRY item from the menu, and enter the code again to turn off the protection. The display for MENU ENTRY will display ENABLED when protection has been disabled.

Job Configuration

SB-5522-6 note: This menu option exists for this product version only. It allows selection between the default 32 JOBS configuration (M1/M2 is disabled), or the 16 JOBS + M1/M2 configuration. This setting allows M1/M2 behavior for this product for continuity with the other AEMS card products.

Factory Settings

Allows restore of all general Menu settings to factory defaults. Does not affect M1 or M2 Parameters.

Job# (Job No.) - Multiple Parameter Sets

This menu allows multiple job setups to be stored for future reference and easy retrieval. This is useful in cases where changes in the workpiece, grinding wheels, or other distinct variables in the grind or dress process might change the AEMS system settings required to correctly monitor these different jobs.

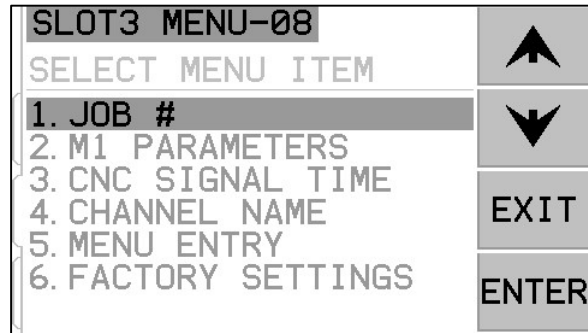

The Job# setting is optional, and is by default set to “OFF”. In this state only two sets of parameters are stored, one each for M1 and M2 mode. By Selecting the MENU option JOB#, the user will be able to setup and save up to 16 separate pairs of parameters, an M1 and M2 pair for each job number, providing total storage of 32 separate setups. When Jobs are in use, the current selected Job No. (01 to 16) is displayed at top of screen in the blue identification bar. The JOB# menu item will also move to the top of the MENU list, making selection of various job numbers more convenient. **SB-5522-6 note:** When the 32 JOBS configuration is selected, the M1/M2 function is disabled and instead each saved configuration is treated as a separate job (1-32).

Important – JOB# selection can be made via the Software or Profibus interfaces on the Control but cannot be made via the Hardwire interface. The Hardwire interface can only select between M1 or M2 for the current JOB#. Once a user has selected an individual JOB#, it will remain the active Job until changed.

When new Jobs are created for the first time, the current settings from M1 and M2 in Job 1 are used as default settings for the new Job. Once a Job has been added, it must be setup for proper use by running a Learn Cycle and making any other needed parameter settings.

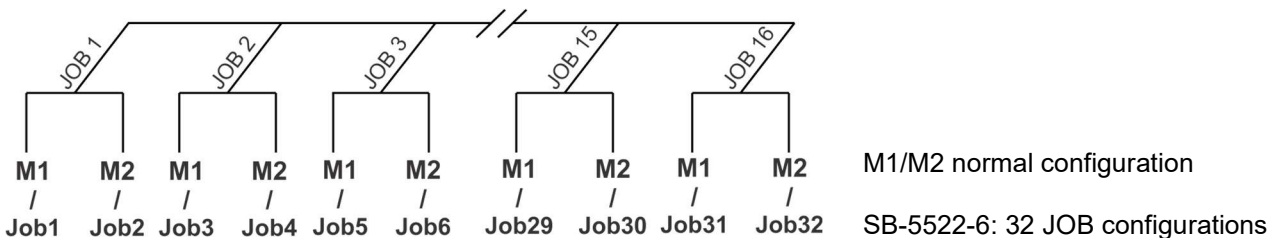



Screen

The first three items on this screen are available for use only when screen Plot Scaling is set to LINEAR mode. When the screen is set to Log mode, access is only provided to the Zero Offset function.

 screen Zoom – Use up and down arrow keys to change screen Zoom. Zoom allows the screen vertical scale and resulting view to be zoomed in (and also adjusted back out) to focus on a particular area of interest, for instance on low signal levels. Zoom will allow the top portion of the screen to be adjusted off screen.

 screen Pan – Use up and down arrow keys to change screen Pan. Pan allows the screen to be shifted in view vertically relative to the current screen zoom setting. If no screen Zoom has been set, then the screen is shown full scale, and therefore no Pan is possible.

 signal Gain – Use up and down arrow keys to change signal Gain. Allows manual setting of the Gain level used to measure signal. Increasing the Gain much beyond the Gain set by the Learn process will raise the C Limit beyond the usable range of the hardware, resulting in Error D.

 Zero Offset – On this screen adjust the Zero offset which can be used as an offset for the vertical scale of the signal display. Only when the signal rises above the offset level is signal displayed. Press SET button to set the offset value to the current unadjusted AE signal level. This value is selected at the moment the SET button is pressed. In the screen shown at right, 0.000 is displayed as the current Zero offset setting, which is displayed above the CLEAR button. Pressing SET would change the offset value to the current signal level (0.306, assuming the signal is constant). This number would then be displayed as the current Zero offset above the CLEAR button, and all signal display values would be shifted by this amount. CLEAR button will eliminate any saved setting and return the Zero offset value to 0.000. When a zero offset is made the Limits remain unchanged in position relative to the signal level. This means that although the vertical scale has been changed, the offset value is subtracted from each limit for display to ensure that the limits remain relatively in the same position to the AE signal level. **Important** – Use of the Zero offset feature can potentially move limit settings above the usable hardware range, causing an Error D condition. If this occurs, reduce the zero offset, or reduce the system gain to compensate.

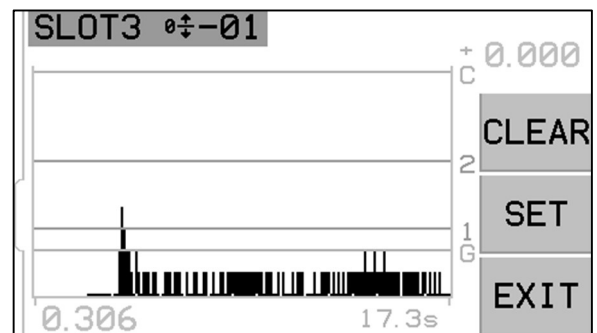
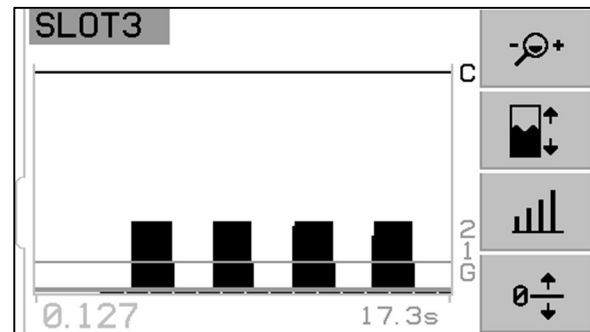

AEMS Operation

M1 and M2 Parameter Menu

This menu covers those operating parameters which are saved specific to each M1 and M2 mode, and each separate Job.

Learn Cycle

The Learn Cycle is a process to assist with setup for proper operation. Initiating a learn cycle allows operating parameters to be determined and properly set for each distinct work process to be monitored (M1/M2/Job). The learn cycle will set the system signal gain and overall measurement scale, as well as help determine which of the eight frequency bands should be selected for best results. During the learn cycle the background AE signal levels for each of the eight frequency bands will be compared with the signal levels that occur during normal dressing or grinding contact, and the frequency band with the best Work/Air signal ratio will be suggested as the frequency to be monitored. **Important** - If the results of the Learn process produce Work/Air ratios that are 1.2 or below, then the system has been unable to see any significant difference between the AE signal during wheel contact and prior to wheel contact. This is usually a result of either an improperly performed Learn cycle, or a poor AE sensor location or installation.

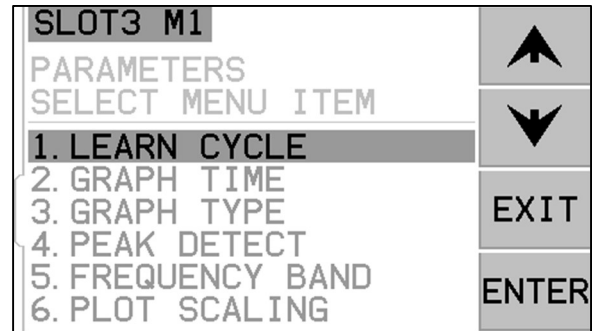

A separate learn cycle must be run for both M1 and M2, and resulting parameters are stored separately for each mode and each Job. The learn cycle will properly set up the gain and other parameters needed for correct operation in the selected monitoring mode. After pressing SETUP to enter the setup menu, press the MENU button, followed by selecting either M1 PARAMETERS or M2 PARAMETERS, depending on the currently selected mode. Next select LEARN CYCLE to activate the learning cycle for the mode selected.

Learn AIR

The first window will show eight bar graphs, representing the current signal levels for each of the separate frequency bands covered by the unit. The screen is titled AIR PASS. The bar graphs will rise and fall as signal levels change. The VIEW DATA button is only available if a previous Learn Cycle has been run for the selected parameter set. It allows the user to view the Data screen results of the previous learning cycle run, and from there select an alternate frequency band based on those results.



The first step in performing a learn cycle is to learn the background or AIR signal level. To do this the machine should be operational, with all systems running, but **without** wheel contact with the part or dresser. Once the graph has settled, press START to begin learning. Move the wheel through a mock grind or dress movement, **without** wheel contact (the bar graphs may rise a little during this process). When finished, press the ►► button to store the maximum background/AIR levels recorded in each frequency band, and to move to the next phase of learning.

Frequency bands defined

The eight operational frequency bands are defined to cover a wide range of possible applications, while still covering adequate bandwidth for good signal acquisition.

Band No.	1	2	3	4	5	6	7	8
Center Frequency kHz	110	220	330	440	550	660	770	880
Bandwidth kHz	124	124	124	124	124	124	124	124

Frequency Band Selection and Short Work Cycles

The Learn Process is shown here as it is normally run using all eight frequency bands. When a work or dress process is very short in duration (3 seconds or less), it may be difficult to capture good signal data for all eight frequency bands during the Work learn process. Running multiple part or dress cycles while remaining in learn WORK mode will accumulate Work data across all eight bands. This method should be used for short part/dress cycles. The best frequency band to be used for an application is a function of the machine structure, sensor location, and other process factors which often do not change much from one process to the next on the same grinder. Once the best frequency band for an application is determined, it is no longer necessary to use this method or running multiple part/dress cycles. The SETUP button from this screen will access a menu allowing the user to select a single band for the Learn Cycle and subsequent operation.

When a single band is selected for use, only that band will display data on the Learn AIR, Learn WORK, and Learn

Set Frequency Band 8

To provide additional flexibility in operation, when frequency Band 8 is selected it can be customized to operate with a user defined frequency band. This customization may be helpful in preventing problem noise sources from being included in the evaluation, or when operation is best focused on a range that does not fit with one of the 8 predetermined frequency bands. After selecting Band 8 from the Band Selection menu, the user can enter a desired Center Frequency for the band (13 to 900 kHz), and a desired bandwidth from a list of available options (10, 14.4, 20.5, 29.4, 42.2, 60.4, 86.6, 124.0).

Important – Care should be taken when setting the bandwidth. It is possible to set the band such that part of the bandwidth falls below zero and is therefore off scale. This will allow more noise into the measurement. Also the narrower the bandwidth is set, the lower the total AE signal will be measured. This is because AE signal generation from wheel contact is very broad in frequency and so narrowing the bandwidth monitored will likely reduce the total signal power.

SB-5522-6 Sensor Selection

For the SB-5522 card the sensor number assigned to the currently selected parameter set (Job and M1/M2) is displayed in the upper right corner of the Learn screen as shown. **SB-5522-6 note:** An additional button is displayed at this location, showing the currently assigned sensor (-① to -⑥). Pressing this button will access a menu allowing the user to select from a list of all currently connected sensors, to select the desired sensor to be used with the current parameter set.

Learn WORK

The screen should now be reversed in color from the previous screen, and is titled NORMAL WORK PASS. The operator should now initiate normal wheel contact with the dresser or part, and complete one or more cycles, until the bar graph is stable. The “-” symbol on each frequency band bar graph will change to a “+” symbol when significant signal increase is measured over the AIR level recorded for that band. This process records the maximum signal levels during normal grinding or dressing, so the bar graphs will always show the highest levels recorded during this current learning cycle. Once the bar graph has stabilized, press the ►► button to store this information and display the resulting data screen.

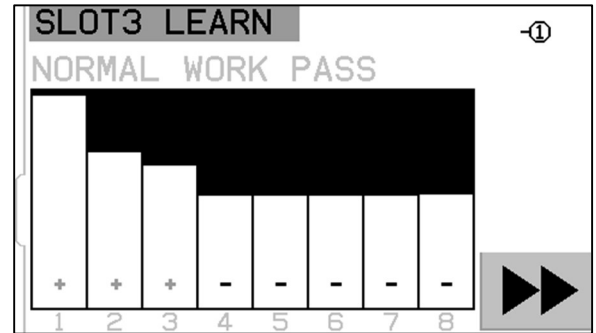

Learn Data screen

The data screen will show results of the Learn cycle, including AE signal WORK and AIR levels recorded for all eight frequency bands. The resulting ratio between WORK level and the background AIR level (W/A) is displayed as well as the signal gain setting , and the Crash Sensitivity (C.S.), which is a factor of how much higher the Crash limit can be set above the normal WORK signal. The bands are presented in 1-8 order. Bands with poor results (low C.S. and/or low W/A) are displayed in red color. Bands with good results are displayed in blue. The frequency band selected as by the control unit for optimal monitoring is highlighted. This selection is based on the highest W/A ratio, within all results with good results (blue). Press ENTER to accept this choice, or override the AEMS system selection by choosing another frequency band with good results, and then press ENTER. Press EXIT twice to exit the setup menu, and return to the Main Screen.

SLOTT3 LEARN						▲
	WORK	AIR	W/A	Gain	C.S.	▼
1	5.727	0.164	35.0	0.00		
F	WORK	AIR	W/A	Gain	C.S.	
1	8.702	0.134	64.7	21	3.00	
2	0.073	0.068	1.1	63	3.00	
3	0.058	0.044	1.3	63	3.00	
4	0.034	0.034	1.0	63	3.00	
5	0.027	0.025	1.1	63	3.00	
6	0.022	0.022	1.0	63	3.00	
7	0.019	0.019	1.0	63	3.00	
8	0.017	0.017	1.0	63	3.00	

Verify Normal Operation

The Main Screen can be stopped or started by toggling the lower right-hand button. When running, the screen will display real time acoustic level information, as it occurs. When stopped, the screen shows the last time period recorded. Verify that the heading for the screen reads either M1 or M2 and that the mode selected is correct. When the wheel is not making contact, the screen should show signal levels below the lowest limit line, near the bottom of the screen. **If the signal level is above the lowest limit set, you should repeat the learning cycle or move the lowest limit to achieve proper results.** The C (Crash) limit level is set automatically during the learning cycle and can be adjusted from this setting manually using the LIMITS menu setting.

Initiate wheel contact with the dresser or work-piece, and observe the running display. You should see the acoustic levels falling between the 1 (LIMIT 1) and 2 (LIMIT 2) levels during full contact, and dropping off below the G level between passes. The 1 and 2 levels usually are set to indicate the normal minimum and maximum levels for grinding or dressing. These levels can be adjusted by the operator as needed to bracket the normal operation range. If results are not as described, try the following.

- Run the Learn process again. Ensure that AIR and WORK signal levels recorded are corresponding correctly to timing of the grind or dress cycle. AIR must be recorded only when the wheel is not making contact. WORK must be recorded with normal amount of wheel contact and for a long enough duration to capture good signal. If Work cycles are very short, try limiting the Learn cycle to a selected frequency band for best results.

- b) Verify the AE sensor is well mounted. Try an alternate AE Sensor location, and re-run the LEARN cycle. Try moving the sensor closer to the point of wheel contact on the machine structure, as described in Acoustic Sensor Location section of this manual.

Graph Time

Graph Time adjusts the time scale the AEMS system uses to display data on the screen. The Graph time set represents the number of seconds taken to scroll across the display screen, so the width of the screen then reflects the data taken in this same time period. The default time is 11.4 seconds and can be set up to 365 seconds. A longer Graph Time will display data over a longer period of time, but at a lower resolution.

Graph Type

Graph Type switches the AE signal graph between a filled graph or an unfilled line graph.

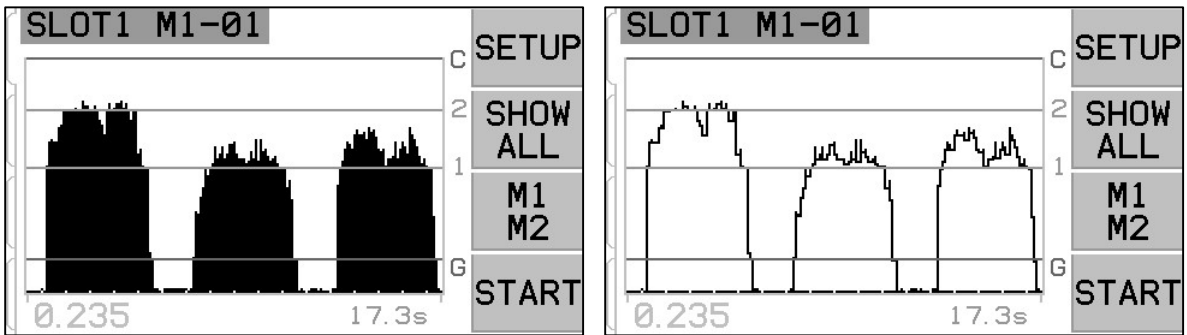

Peak Detect

When this setting is turned ON, peak AE signal levels are displayed on the Run View screen. Peak values are defined as the highest signal value seen during the period of time that the signal rises above the G limit, and then falls again below the G limit and remains below that limit for a minimum of 10 effective screen pixels of display. The effective screen pixel size (each discrete displayed signal level) will vary in size based on the screen graph time.

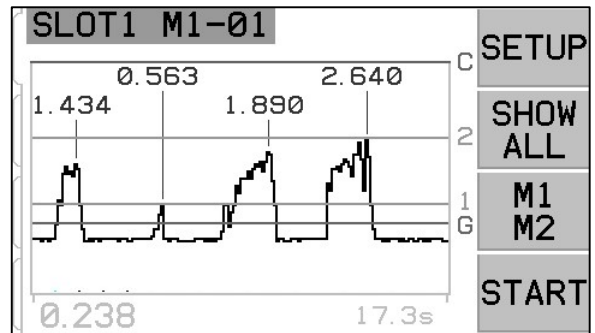

Frequency Band

Allows the manual selection of the currently selected Frequency band used for monitoring AE signal. **Important** - when selecting another Frequency band, signal Gain and other the other parameters normally set via the Learn Cycle must also be set or adjusted for proper system operation.

Plot Scale

Select Log (logarithm) scale or Linear scale for the vertical scale of display signal level and Limit positions. A log scale shows higher resolution at the lower part of the scale and reduces in resolution as signal increases. This allows low signal levels to be displayed well, while keeping most high signal level signals onscreen. A linear scale assigns equal numerical value to all portions of the signal scale. The linear scale setting is needed to enable manual settings for screen Zoom, screen Pan, and system Gain. The screen scale is set by default to Log.

Hardwire Interface

Interfacing the SBS System with a CNC or PLC machine controller is supported via a hardwire interface or software interface. The hardwire interface is provided via a standard DB-25 connector located individually on the rear panel of the AEMS Card, while the Software interface is supported via either the USB or Ethernet connections, which are common to the whole control unit. Because of the many possible variations and configurations of cabling required for such an interface, it is left to the operator to supply the necessary cable.

When designing an interface for the SBS System, it is important to understand that the grinding machine's controller must operate the SBS System. It is not possible for the SBS System to control the grinding machine.

Carefully read this entire manual before attempting to interface the SBS System with any machine controller. Sections covering the interface of other SBS products installable in the SBS Control are covered separately in the manual addendum for such products.

Hardwire Control Interface – AEMS Card

The hardwire interface consists of three sections: interface power supply, the inputs, and the outputs.

The interface power supply is provided exclusively for use with the hardwire interface inputs. It consists of three common pins and one output pin. The common pins are internally connected to chassis and earth ground. The output provides a maximum of 30 mA at approximately +15VDC. Any external power used for interface I/O must be from a SELV (Safety Extra Low Voltage) source or supply.

The three inputs provide noise immunity and robustness. The inputs are activated by being pulled high, either by connection to the SB-5500 hardwire interface power supply output or by connection to a customer supplied signal. Activating the inputs requires at least 8 mA at a voltage between 10 and 26 volts, AC or +DC, referenced to the SB-5500 hardwire interface power supply common. The inputs are deactivated by removing the connection to the power or signal source.

The four outputs consist of optically isolated, single-pole/double-throw solid state relays. These solid-state relays may be used to supply an output signal by connection to a voltage source supplied by the customer. The output contacts are electrically isolated from all other circuits and are rated for 24 Volts DC or AC, 50 mA maximum. Inductive loads must be protected against flyback to 50VDC.

The three contacts of a single-pole/double-throw solid state relay are referred to as “normally open”, “normally closed” and “common”. The term “common” in this sense does not imply connection to power supply commons. The term “return” is used below to indicate the common contact of the output.

DB-25 Connector

For SB-5522 AEMS

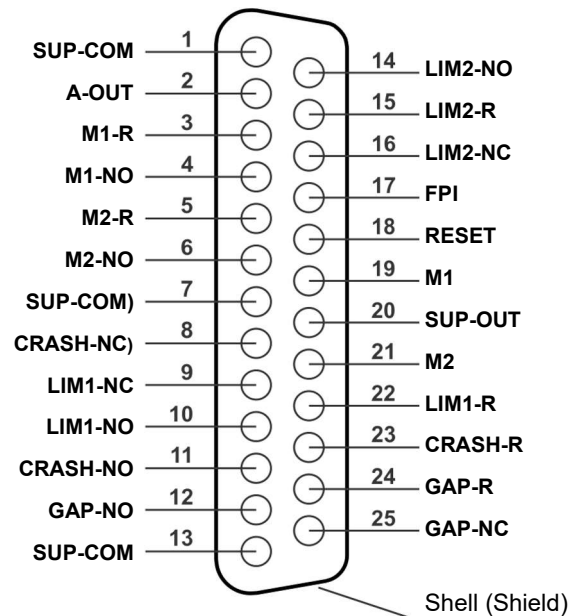

Input Pin Names and Functions

Pin#	Name	Description
17	FPI	Front Panel Inhibit- While this input is held active, most operator actions at the front panel keypad are disallowed. Specifically, the SETUP button, the M1/M2 button, and the START/STOP Button are disabled. Still enabled are the Power button and the SHOW ALL button. This affects the operation of this AEMS card only.
18	RESET	Crash Reset. The crash status latch will be reset following the rising edge of a voltage applied to this input. A crash that occurs while voltage is applied will not be reset. The voltage must be removed and reapplied. This input is ignored if the CNC Crash latch is set to OFF.
19	M1	<p>Activate this Input to select M1 mode and initiate AEMS operation using the M1 parameters. Selection will be made following the rising edge of a voltage being applied to this input.</p> <p>Option: When STOP/START CONTROL SOURCE is set via the menu to allow CNC control of the screen STOP and START functions, this input will provide control of this function also. When this mode is selected, the screen will continue to scroll (with new data being displayed) only while this input is held active. Following the removal of voltage from this input, the control card will STOP the display, until voltage is applied again.</p>
21	M2	<p>Activate this Input to select M2 mode and initiate AEMS operation using the M2 parameters. Selection will be made following the rising edge of a voltage being applied to this input.</p> <p>Option: When STOP/START CONTROL SOURCE is set via the menu to allow CNC control of the screen STOP and START functions, this input will provide control of this function also. When this mode is selected, the screen will continue to scroll (with new data being displayed) only while this input is held active. Following the removal of voltage from this input, the control card will STOP the display, until voltage is applied again.</p>

Output Pin Names and Functions

Pin#	Name	Description
2	A-OUT	Analog signal output (0-10V, 2mA max.) referenced to SUP-COM. See following section for further details.
4	M1-NO	Closed to indicate the M1 parameters are in use. note: If an error code condition occurs on the control, both Pins 4 and 6 are closed at the same time. Both pins open at the same time indicates the control is either OFF, or in a LEARN cycle.
3	M1-R	Common return connection for the M1 output
6	M2-NO	Closed to indicate the M2 parameters are in use. (see note under pin #4).
5	M2-R	Common return connection for the M2 output.
11	CRASH-NO	Closed to indicate a crash condition. Latches if the CNC crash latch is on.
8	CRASH-NC	Closed whenever Crash-NO is open (no error condition detected). It is also closed when power is off and during standby, initialization, self-test, and learn modes.
23	CRASH-R	Common return connection for the Crash output.
12	GAP-NO	Closed whenever the AE signal is at least at the Gap setting (wheel contact detected).
25	GAP-NC	Closed whenever GAP-NO is open indicating that the AE signal is below the Gap setting. Also closed when power is off, during standby, initialization, self-test, and learn modes.

24	GAP-R	Common return connection for the Gap output.
10	LIM1-NO	Closed whenever the AE signal is at least at the level of the LIM1 setting.
9	LIM1-NC	Closed whenever LIM1-NO is open indicating that the AE signal is below the level of the LIM1 setting. It is also closed when power is off and during standby, initialization, self-test, and learn modes.
22	LIM1-R	Common return connection for the LIM1 output.
14	LIM2-NO	Closed when the AE signal is at least at the level of the LIM2 setting (excessive grind pressure).
16	LIM2-NC	Closed whenever LIM2-NO is open indicating that the AE signal is below the LIM2 setting. Also closed when power is off, during standby, initialization, self-test, and learn modes.
15	LIM2-R	Common return connection for the LIM2 output.
20	SUP-OUT	A protected supply referenced to the Supply Common connection. It will be adequate to operate any combination of the CNC inputs on the CNC connector.
1,7,13	SUP-COM	Common reference connection for the CNC input pins on all channels, connected to earth and chassis ground. This connection is for the common of the external supply, when one is used to activate the CNC input signals.

AE Signal Analog Output

The analog output voltage is presented at pin 2 of the 25 pin CNC connector of the SB-5522 card. Pin 1 is the ground reference for this voltage. The analog output on the AEMS system is not calibrated to a fixed level. The gain of the system is auto scaling, so that the analog signal output always falls in the 0-10 VDC range. This auto scaling is needed to accommodate the huge variation in signal level, which can be measured on various types of grinders with different applications and sensor placements. This gain corresponds to the gain used for the display of AE level on the front panel. This scale will vary with the Gain setup saved for each parameter set (M1/M2 and Job). It will also potentially change every time a learning cycle is run, if gain is adjusted.

Note that there may be no correlation between the gain settings, and the resulting voltage levels for each separate M1 and M2 mode.

Full Scale = 9.7 VDC = near full scale of hardware amplifier

Profibus DP Interface

A Profibus Implementation document, along with the required Profibus GSD file, can be downloaded from the SBS website at <https://accretechsbs.com/>.

Software (USB or Ethernet) Interface

The SBS System provides a software interface via either Ethernet TCP/IP or USB. The software interface allows the same control capability as the hardwire interface plus system status monitoring. The following description applies to all SB-5500 models.

Interfacing

The software interface provides a serial interface emulation which connects the Control to a Windows computer over either Ethernet TCP/IP or USB. For TCP/IP, use Telnet at the Windows command prompt pointed to the IP address of the Control, or use HyperTerminal or similar serial communications software pointed to port 23 with any baud rate setting. When connecting via USB, Windows will assign a COM port to the control. If the SB-5500 is not automatically assigned a COM port, a driver for Windows installation of USB-Serial communication is available on the SBS website at <https://accretechsbs.com/>. COM port assignment is controlled by Windows, and a unique COM port will be assigned for each detected SB-5500 control. The port assigned can be determined by viewing Windows Device Manager. Use HyperTerminal or other serial communications software to interact with the Control over USB connection.

Software Commands and Responses

When the Control unit is first powered up, the following message is transmitted via the software interface.

**/SB-5500, Copyright (c) 2020, Accretech SBS, Inc.<CR>
V0.85<CR>**

Commands - A message preceded with the digit '1' through '4' is a command or response referring to Slot Cards 1 to 4, respectively. A message starting with any other character refers to the System Control. Examples following use "1" as the card slot number.

The following commands from the Software Interface are available:

Control Unit Commands (Cards are Individually Controlled)		
Command	Response	Meaning/ Example:
C		Control Panel Status Inquiry. <Esc>C<CR>
	CI	Control Panel is Inhibited CI<CR>
	CE	Control Panel is Enabled CE<CR>
	CX	Control Panel is not installed CX<CR>
CE		Control Panel Enable. <Esc>CE<CR>
	K	Command Acknowledged K<CR>
	CX	Control Panel is not installed CX<CR>
CI		Control Panel Inhibit. <Esc>CI<CR>
	K	Command Acknowledged K<CR>
	Q	Command Not Accepted (Panel in use?) Q<CR>
	CX	Control Panel is not installed
V		Version Request (main board firmware). <Esc>V<CR>
	Vn.nn	Firmware Version V1.00<CR>

AEMS Card Commands (Cards are Individually Controlled)		
Command	Response	Meaning/ Example:
X		Type (of slot card) Request. < Esc >1X<CR> Start Slot 1 Info Request.
	X3.xxVv.vv [sss]/text	Slot info response. 3 is Gap/Crash type. xx is specific model type. v.vv is gap firmware revision. sss is the user specified name for this card. Text briefly explains the card type. 1X3.00V1.00[GAP1]/Gap / Crash<CR>
S[C]		Status Request command. If 'C' present then previously reported errors conditions will be cleared before the status is reported. <Esc>1S<CR> Report Slot 1 Status.
	S{D G}aaaa [,CIP][,FPI] [,GAP] [,LIM1] [,LIM2] [,CRASH], ERR=eee	Status response. D or G indicates current mode (D=M2 or G=M1), aaaa is AE level. CIP is Cycle In Progress. FPI is Front Panel Inhibit. GAP, LIM1, LIM2, and Crash the corresponding output is closed, eee represent individual error letters representing error conditions. If the first character is '@' then an error condition requires clearing (use SC command or press clear on front panel). 1SD2.905,CRASH,ERR=@AB<CR> <ESC>1SC<CR> Report Slot 1 Status. 1SD2.912,ERR=B<CR>
C[D G S A nn]		Cycle Command: If D or G, will change to the corresponding mode (D=M2 or G=M1). If nn will change to corresponding Job# parameter set (nn range 0-16, 0 turns Job# OFF). If S or A then will Start or Abort the measurement process, correspondingly. No response to D, G, A or nn.

AEMS Card Commands (Cards are Individually Controlled)		
Command	Response	Meaning/ Example:
		<ESC>1C7<CR> Set Job# to 7. <ESC>1CS<CR> Start Cycle.
	{D G}dddd	Cycle data. D or G indicates M2 or M1 value. dddd is AE signal level. These will be sent whenever a cycle is running. There will be no response if the command is not allowed. 1G0.023<CR> M1 Cycle data. 1G0.120<CR> M1 Cycle data. 1G0.134<CR> M1 Cycle data. <ESC>1CA<CR> Abort Cycle. (no response)
L		Level request: <ESC>1L<CR> Request Current Levels.
	Lnn{D G}gggg, aaaa,bbbb,cccc	Level response. nn indicates current Job# parameter set. Nn=0 for OFF, nn=1-16 for current Job#. D or G indicates current mode, M2 or M1. Levels are gggg for Gap, aaaa for Lim1, bbbb for Lim2, and cccc for Crash. Levels are different for each mode (D=M2 or G=M1). 1L7G0.023,0.145,1.056,3.112<CR> M1 mode levels.

Displayed Error Messages

Self-diagnostic software has been incorporated into all SB-5500 Control Units. If a problem ever occurs with an SBS system, It is reported on the front panel display as an error code. Below is a listing of these error codes, a description of when the Control Unit automatically runs each test, how each code is cleared, the definition of each error message, and prescribed action to be taken by the user.

Press CLEAR or CANCEL to manually clear a displayed error message. Once an error is cleared, it will be displayed again when the error condition is next detected. To further isolate defective components a series of test operations accompany some of the error codes.

Please indicate the Error Code (letter) of any displayed Errors when returning equipment for repair. Also please provide as much detail as possible regarding the conditions when problems were encountered, and the symptoms experienced.

Error Code	Message	Definition	Action
A	SENSOR 1 DEFECT (SENSOR 2 DEFECT) OPEN – CHECK CABLE AND CONNECTORS SEE MANUAL	Checked continuously. Acoustic Sensor 1 (2) presence not detected. This could be caused by a defective sensor or by no sensor being connected.	Clears automatically when sensor detected. Check sensor connections and try Power-On again. Continued error messages indicate the need for repairs to the Sensor.
B	SENSOR 1 DEFECT (SENSOR 2 DEFECT) SHORT – CHECK CABLE AND CONNECTORS - SEE MANUAL	Checked continuously. Acoustic Sensor 1 (2) short circuit detected.	Clears automatically. Disconnect the Control Unit from AC power before checking cables and connectors, and sensor for shorts. If the problem cannot be isolated, the sensor, cable, and/or Control Unit should be returned for repair.

Error Code	Message	Definition	Action
C	<u>ANALOG OUTPUT SIGNAL OUTPUT DAC OUT OF RANGE</u>	Checked continuously. Analog output is out of range.	Analog output (0-10V) of AE signal cannot track the range set by current Gain and Crash settings. Reduce Crash limit or Gain as needed to resolve.
D	<u>LIMIT RELAY RELAY SET BEYOND USABLE RANGE</u>	Checked continuously. One or more Limits are set outside useable range.	Limits are set beyond the functional range of the hardware. 1. If input AE signal is too high it may overwhelm the hardware limits of the AEMS card. In this condition selecting a different frequency band (one with normal 3.0 C.S.) should resolve the problem. 2. Remove or reduce the zero offset. 3. Try reduced Gain.
E	<u>+15V POWER DEFECT SHORT – CHECK CABLE AND CONNECTORS – SEE MANUAL</u>	Checked continuously. 15V Auxiliary supply low – fuse open	Check for shorts in Sensor and CNC cables and connectors and re-initialize the system. If the error persists return Control Unit and cables for repair. If you have the SBS system cabled to your CNC controller, verify that the CNC cable is free of electrical shorts. The CNC cable is not supplied with the SBS system, and repair is the responsibility of the user.
F	<u>Crash CONDITION</u>	Checked continuously. Unit has measured acoustic signal exceeding the set Crash limit.	Cleared manually by pressing “Clear” button or by CNC RESET. Check for part crash. Reset Error.
G	<u>CIRCUIT FAILURE UNABLE TO MEASURE AE SIGNAL SEE MANUAL</u>	Checked continuously. Signal acquisition circuit failed.	Clears automatically. No action required other than clearing manually from the screen. If the problem persists, the Control Unit should be returned for repair.
I	<u>DISPLAY FIRMWARE NEEDS TO BE UPDATED TO SUPPORT FUNCTIONS SEE MANUAL</u>	Checked at power on.	The firmware on the display PCB must be updated to the current version to support interface changes in the newer device card firmware.
J	<u>CARD IS DISABLED REMOVE EXCESS CARDS</u>	Checked at power on. Only 1 of certain device card models can be installed in the control unit.	If more than one SB5519 is installed, all cards are disabled. The error indicates the need to remove the excess installed cards.

Support

For support, contact the machine builder or SBS at:

Accretech SBS, Inc.
2451 NW 28th Avenue
Portland, Oregon 97210 USA

Tel.: +1 503.227.7908
Fax: +1 503.223.1258
TechSupport@accretechSBS.com
<https://accretechsbs.com/>

Appendix A: Specifications

SB-5500 Physical Features

Multiple Device Control

Four (4) available slots accept these control cards:

- SB-5512 Mechanical wired balancers
- SB-5518 Hydro Balancers
- SB-5522 Acoustic Emissions Monitoring System
- SB-5523 ExactDress™ process monitoring
- SB-5560 ExactControl™ process monitoring
- SB-5562 Studer AE Control™ process monitoring
- SB-5532 Mechanical non-contact balancers
- SB-5544 Manual balance control

SB-4500 Compatible

Operates with existing cables and sensors,
CNC/PCL Hardwire Interface

Display

Type: Color TFT LCD

Active area: 480H x 272V pixel

3.74 inch [95mm] x 2.12 inch [53.86mm]

Multi-language Capability

English, Chinese, French, German, Hungarian, Italian,
Japanese, Polish, Portuguese, Russian, Spanish,
Swedish

Communication Interfaces

Ethernet TCP/IP, USB 2.0, Profibus DP, CNC/PLC
Hardwire Interface (opto-isolated outputs)

DC or AC Power Options

DC Supply: Input 21 VDC to 28 VDC. 5.5A max at
21 VDC. Reverse voltage protected.

Connector: Molex 50-84-1030 or equiv.

Contacts: Molex 02-08-1002 or equiv.

AC Supply: 100-120 VAC, 50/60 Hz, 2A max; 200-
240 VAC, 50/60 Hz, 1A max. Main
supply voltage fluctuations not to
exceed +/-10% of nominal supply
voltage.

Environmental and Installation

SB-5500

Pollution degree 2

Installation category II

IP54, NEMA 12

Environmental temperature range: 5°C to +55°C

SB-5575/80/76/81

Pollution degree 2

Installation category II

IP20

Environmental temperature range: 5°C to +55°C

CNC Hardwire Interface

Input requirements: 10-26V AC/DC, 8mA min.

Output +15VDC, 30mA max.

Appendix B: Replacement Parts List

Part#	Description
AEMS Sensors	
Built in to Non-contact Balancers	
SB-42xx	Bolt-on Sensor
SB-41xx	AE-Extension Cable
SB-3208	AE Sensor: Non-contact spindle mounted Mini-Stud Mount – M6x1.0 LH
SB-3209	AE Sensor: Non-contact spindle mounted Mini-Stud Mount – M6x1.0 RH
SB-3225	AE Sensor/ Sender Package: Non-Contact In-Spindle
SB-3210	AE Sensor: Non-Contact In-Spindle w/ slide tube connection
Control Mounting Hardware Options	
SK-5000	Rack Panel: SB-5500, Full Wide w/ 1/2 Blank, 3U
SK-5001	Rack Panel: SB-5500, Partial Wide 3U w/ Handles
SK-5002	Rack Panel: SB-5500, 1/2 Rack 3U Bracket
SK-5003	Control Mount: SB-5500, Bottom Flange
SK-5004	Control Mount: SB-5500, 90 Deg. Bracket, Cabinet
SK-5005	Keypad Mount: Flush Panel Frame Kit
Other Parts	
EC-5605	A/C Control Fuse, 3 amp time lag 5x20 (2 required)
EC-5614	D/C Control Fuse, 6.3 amp time lag 5x20
CA-0009	Power Cordset
CA-0009-G	Power Cordset (Germany)
CA-0009-B	Power Cordset (British)

xx in P/N = cable length in feet

Standard options 11 [3.5m], 20 [6.0m], or 40 [12.0m], e.g. SB-4811 = 11ft [3.5m]

Appendix C: AEMS Card Installation

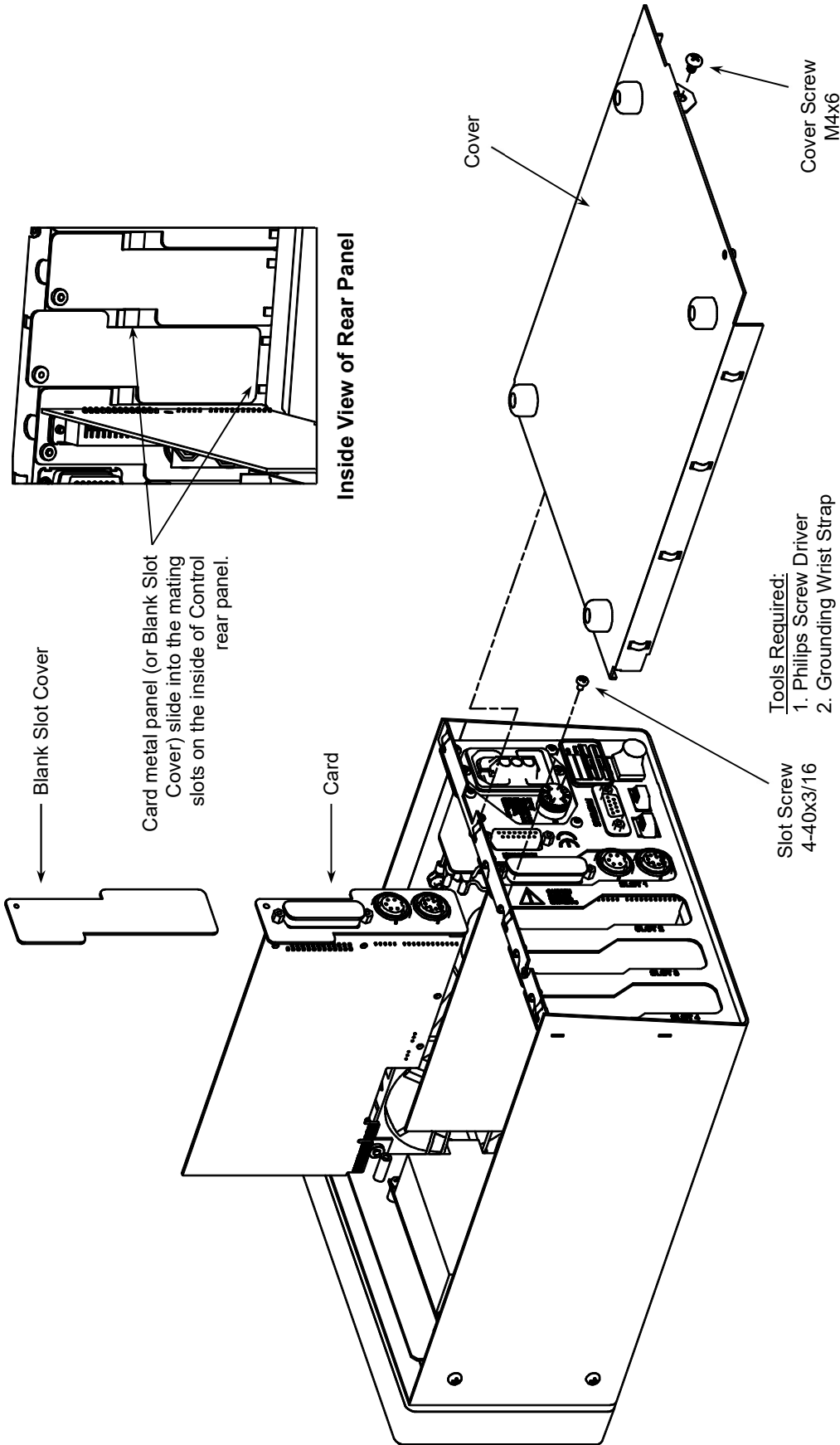

Unit is shown upside down with the cover removed.
Safe handling requires that technician have the unit open or cards out of ESD bags only on an ESD-safe work surface, and only when the technician is properly grounded

Note: All Service (including card installation) should be performed by a qualified technician, or the unit returned to Accretech SBS, Inc. for service.

Tools Required:

1. Philips Screw Driver
2. Grounding Wrist Strap

Procedure:

1. Unplug Unit, invert, and lay on an ESD Safe Surface.
2. Remove Cover Screw at Back Panel of Control.
 For small chassis (e.g. SB-5575) remove 4 cover screws.
3. Remove Slot Screw and Blank Slot Cover.
4. Plug Card into Main Circuit Board while sliding Card metal plate into mating slots on inside of Rear Panel.
5. Install Slot Screw to secure Card.
6. Install Cover and Tighten Cover Screw.

Appendix D: AEMS System Connection Diagram

